

Amateur Joinery in the Home

A Practical Manual for the Amateur Joiner
on the Construction of Articles of
Domestic Furniture

BY

GEORGE ASHDOWN AUDSLEY, LL.D.

ARCHITECT

AUTHOR OF "THE ART OF ORGAN-BUILDING," "THE PRACTICAL DECORATOR," ETC.

AND

BERTHOLD AUDSLEY, ARCHITECT

WITH TWENTY-TWO PLATES AND TWENTY-NINE
TEXT ILLUSTRATIONS.

BOSTON

SMALL, MAYNARD AND COMPANY

PUBLISHERS

1916

Rm

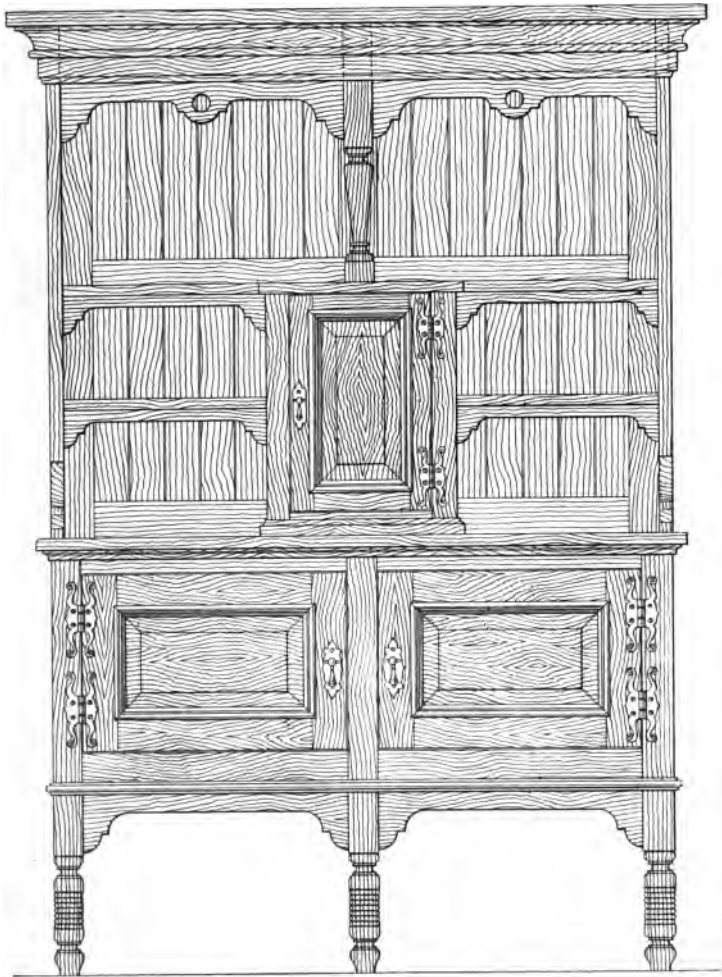

12 0 1 2' 3'

PREFACE

IN offering the present Manual to the amateur interested in the Art of Joinery, we trust it will be found sufficient, in all essentials, to instruct him in the methods of working necessary for the easy construction of articles of use and beauty. We have written it in the simplest and most concise style, so as to prevent any confusion or misunderstanding in the mind of the amateur: and have furnished him with a series of designs, carefully drawn and detailed to scale, such as has never before been given in a handbook on the Art of Joinery. From these designs the amateur cannot fail to select a suitable article on which to try his skill.

All the illustrations have been specially drawn by us, with the exception of the few engravings given in pages 43 to 50, which have been kindly contributed by Mr. Richard Melhuish.

G. A. A. AND B. A.

CONTENTS

CHAP.	PAGE
I. INTRODUCTORY	3
II. WOODS SUITABLE FOR JOINERY	11
III. TOOLS AND THEIR USES	27
IV. METHODS OF CONSTRUCTION	59
V. DESCRIPTION OF THE PLATES	83

LIST OF ILLUSTRATIONS

FULL-PAGE PLATES

XX.—A DRESSER SIDEBOARD (*Frontispiece*)

A. (*facing page 36*)

I.—A HANGING BOOKCASE

II.—DUTCH HANGING PLATE-RACK

III.—A SMALL CHAIR

IV.—A STANDING BOOKCASE

V.—AN OCCASIONAL TABLE

VI.—A HALL TABLE

VII.—AN OCCASIONAL TABLE

VIII.—A SMALL TEA-TABLE

IX.—TWO PLANT STANDS

X.—A HALL SETTEE

XI.—DRESS-TREES

XII.—A LADY'S WORK-TABLE

XIII.—A HALL OR LIBRARY ARM-CHAIR

XIV.—A BABY'S CHAIR

XV.—A LIBRARY OR BOOKCASE TABLE

XVI.—A MEDICINE CABINET

XVII.—A TRIPLE PLANT STAND

XVIII.—A MUSIC-ROLL CABINET

XIX.—A SMOKER'S CHAIR

XXI.—A DRESSER SIDEBOARD—DETAILS

To follow
p. 105

ILLUSTRATIONS IN TEXT

FIG.	P.
1. SECTION OF AN EIGHT-YEAR-OLD OAK TREE	.
2. HANDSAW
3. TENON-SAW
4. BOW-SAW
5. FIRMER-CHISEL
6. MORTISING CHISELS
7. GOUGE
8. BRACE
9. BRACE BITS
10. GIMLET
11. MARKING-GAUGE
12. MORTISE-GAUGE
13. TRY-SQUARE
14. MITRE-SQUARE
15. MARKING-AWL
16. SHOOTING-BOARD
17. MITRE-BOX
18. MITRE SHOOTING-BOARD
19. CRAMP
20. FORMS OF HALVING
21. FORMS OF HALVING
22. GROOVE AND TONGUE JOINTING
23. GROOVE AND TONGUE JOINTING
24. JOINTING OF SHELVES, &c.
25. MORTISE AND TENON
26. THE MORTISE
27. THE WEDGED TENON, &c
28. DOVETAIL JOINTS
29. MITRE JOINTS

CHAPTER I
INTRODUCTORY

AMATEUR JOINERY IN THE HOME

CHAPTER I

INTRODUCTORY

THERE can be no question respecting the benefits to be derived from a healthful, useful, and engaging hobby, and especially one that gives interest to domestic life, and which is the means of adding articles of utility and beauty to the home.

Every man, young and old, is all the better for having some decided relief from the routine and unavoidable worries and cares of everyday business; and there is nothing better calculated to give this relief than some employment for both mind and body, in the nature of a chosen and congenial hobby, which calls into play activities calculated to take the mind, for a reasonable time, from business thoughts. Card-playing, billiards, and other indoor games may do this; but they are valueless as to lasting results; and too often lead to gambling and other objectionable indulgences, not to mention serious disturbances of domestic harmony. But such a hobby as that to

which the present Manual may properly lead the way, while it is enjoyable, interesting, and healthful in its necessary bodily exercise, is absolutely without a single objectionable result; on the contrary, it will be the means of adding objects of utility and beauty to the home, which can always be looked upon with pride and pleasure. Great interest is necessarily attached to the works of one's hands, and especially so when they are the results of a hobby widely divergent from one's daily occupation.

It may be truthfully said that the practice of joinery is attended by absolutely no bad effects on either mind or body; and the value of manual training cannot well be overrated. One never knows when life or limb may depend on the expert use of the hand and ordinary tools. A "handless man," in the sense of inaptitude, is a sorry sight when some stern necessity for manual skill arises,—and such occasions are far from being infrequent,—yet how many thousands of men there are in every city in the land who can hardly drive a nail straight, or a tack without hitting a thumb or finger. All parents should encourage their children to use their hands in some amusement which involves the employment of common tools; and, probably, no more suitable present can be made to an industrious boy than a chest of joiner's tools, supplemented by a small bench and a supply of easily-worked wood to operate upon. So far back

as we can remember we were never without such incentives to use our hands; and we have never had to regret our early efforts at the bench and turning-lathe.¹ Apart from other and no less weighty considerations, as a health-giving and strength-building bodily exercise, the practice of home joinery should be widely recognised. The simple operations of sawing, planing, chiselling, and hammering bring into play almost all the more important muscles of the body, and that without unduly straining any of them: this is a consideration of the greatest importance in growing youth. Such exertions as the use of the tools in the operations named above necessitate, practically render the more violent, and oft-times injurious, exercises of the gymnasium unnecessary. A further advantage of such a hobby and instructive occupation as amateur joinery obtains in the fact that it keeps its devotee at home at times when other and probably much less desirable pursuits, or simple laziness,

¹ The following short extract from the "Biography" of the senior author of the present Manual, written in 1881 by Mr. T. H. Hall Caine, the celebrated novelist, points to one of the results of such early training and devotion to a home hobby:

"It should not be forgotten, though it scarcely comes within the limit of legitimate subjects for public criticism, that Mr. Audsley was engaged nine years on and off in the building of a chamber organ, for himself, which, now complete, is admittedly a marvel of perfect workmanship, whether judged of purely by its musical properties (which are said to be unequalled amongst instruments of its size) or by its general outward beauty as an example of exquisite decorative art."

would lead the young man to seek amusement or distraction away from it.

It is probable that in many quarters, where the most favourable disposition may exist, the necessary outlay for a bench and tools will be a deterrent if not a serious stop to the prosecution of the hobby; but when the small sum required for the purchase of the few tools absolutely necessary for the beginner can possibly be afforded, an ample return in health, strength, and other valuable acquirements can reasonably be calculated upon. Later on, when the amateur gains skill and experience, the product of his labour will far exceed in value the outlay expended on tools and materials; while such skill and experience will be of value—and sometimes of great value—throughout his life. In Chapter III. all the tools and appliances absolutely necessary, as well as those which are desirable, are enumerated and briefly described: and in the following Chapter a descriptive list of all the more desirable hard and soft woods for use in joinery and cabinet-work is given, which the amateur will find very helpful.

All the processes of wood-working required in the construction of such useful articles of domestic furniture as are illustrated in the Plates of this Manual, are in themselves extremely simple, and a little practice in the proper use of the ordinary tools will enable the young joiner to achieve very satisfactory results. We

strongly advise the amateur, at the outset, to obtain a few lessons from a practical joiner in the proper handling and use of the several tools required in his work: this simple proceeding will save much time, and, in all probability, will prevent the tools being put out of good order by too rough usage or improper sharpening. When expert teaching cannot be obtained, the directions given in our descriptions of the tools should be carefully followed. It is proper to remark that there are some niceties in the manipulation of certain tools that neither words nor illustrations can properly elucidate; personal instruction, with tools in hand, or well-earned experience, are in such matters the only effective teachers. We do not make these remarks to discourage the would-be joiner; but rather with the desire to assure him that such difficulties as may beset his early essays can be easily overcome by patience and perseverance; and to suggest to him the desirability, as before alluded to, of obtaining some hints and directions from one experienced in the manipulation of the wood-working tools in common use. It is safe to say that there is no village in the country, however small, where such elementary instructions cannot be readily obtained.

The Plates given in this Manual have been carefully prepared so as to provide a series of designs for useful articles of household furniture; the construction of which is within the reasonable capabilities of amateurs

who have become skilled in the use of the ordinary wood-working tools. Sufficient drawings, to scale, are in all cases given, accurately showing the modes of construction; and these are supplemented with details drawn to larger scales. Simplicity, in jointing and in the modes of putting the pieces of each article together, has been observed, so as to give the amateur the minimum amount of labour and trouble consistent with the production of substantial work. Each Plate is fully described, and the most suitable materials to be used in the construction of each article illustrated are suggested. The designs given will in all probability lead to the development of others by the ingenious and tasteful amateur, in which similar methods of construction to those shown can be followed. In the art under consideration, invention and taste are constantly called into play; and, accordingly, individuality can be imparted to every work undertaken.

In this Manual we have devoted no special remarks to wood-turning, because very few amateur joiners are likely to possess a turning-lathe. But to those who may be fortunate enough to have so valuable an accessory, we venture to mention our companion Manual on "The Art of Polychromatic and Decorative Turning"; in which are described certain uncommon processes which lend themselves to the most effective enrichment of articles of furniture. The Manual is fully illustrated with twenty-one Plates.

CHAPTER II
WOODS SUITABLE FOR JOINERY

CHAPTER II

WOODS SUITABLE FOR JOINERY

BEFORE undertaking practical work in the art of joinery, it is desirable that the amateur should possess some knowledge of the nature and peculiarities of the woods most suitable for his use in the construction of articles of furniture, such as are set forth in the Plates of this Manual. A good deal of success depends on the wood selected, in each case, because some woods are easy to work, while others, owing to their hardness and the irregular character of their grain, require considerable skill and practice to manipulate them satisfactorily. It may be said that the amateur, and the beginner especially, should prefer to use woods which are comparatively soft, and have grains which lie, for the most part, evenly and in one direction in any one piece: such woods are, accordingly, easy to cut and dress cleanly. All the more desirable woods are fully described and otherwise commented on in the list given in the present Chapter.

The following particulars respecting the nature of wood generally may be of some value and interest

to the amateur joiner. All the woods used in cabinet-work in this country are the produce of the class of trees designated *Exogens*, signifying their mode of growth; namely, from the central part (or *pith*) outwards. The pith is composed of cellular tissue, which in young stems is succulent and full of fluid, but which in the course of time becomes dry and charged with air. The size of the pith varies considerably; for instance, in the ebony and boxwood trees it is very small, while in the elder it is large. Immediately around the pith lies a fibro-vascular layer, called the *medullary sheath*. Between the vessels of this sheath the *medullary rays* from the pith pass into the wood of the tree. The layers of wood are formed outside the medullary sheath in concentric layers. On account of this outward mode of formation of wood layers, deposited year after year, the stem increases indefinitely. This regular concentric formation has given rise to another name—*Cyclogens*—to this class of trees.

The woody layers vary in their texture at different periods of growth. At first all the tissues are pervious and charged with fluid; but by degrees they become thickened, and the channels of the vessels get filled up and disappear. The first formed layers are, naturally, those which soonest become thus compacted and hardened. In old trees there is a marked division between the inner heart-wood, or *duramen*, and the

outer sap-wood, or *alburnum*,—the former being hard and dense, and often coloured, with its tubes thickened and dry; while the latter is less dense, of a paler colour, and has its tubes permeable by fluids,—hence its name, sap-wood. The difference of colour between the duramen and the alburnum is often very marked. In the ebony tree the duramen is black (the only useful portion), while the alburnum is of a very light colour. In the beech the heart-wood is light brown; in the oak deep-brown; in the laburnum greenish, and in the box and fustic trees yellowish. In certain trees of temperate climates, which yield “white wood,” such as the poplar and willow, no difference of colour appears. The relative proportion of alburnum and duramen varies in different trees. For good work no sap-wood should be used.

From the mode in which the woody layers are formed, it is evident that each vascular zone or ring is moulded upon that which preceded it; and as each ring is completed in the course of one year, the age of a tree can be determined by counting the concentric rings between the pith and the bark. The accompanying illustration, Fig. 1, represents a transverse section of an oak tree eight years old, having eight woody layers. This mode of computation is usually reliable; but from some irregularity in growth more than one ring may be formed in one year. In the section the concentric layers are shown separated by

distinct lines. In trees of this class the pith is not invariably in a central position. The layers of wood may be thicker on one side than on the other, in consequence of their fuller exposure to light and air, or the nature of the nourishment conveyed. When this is the case the pith becomes eccentric. The layers vary in size in different kinds of trees, and at

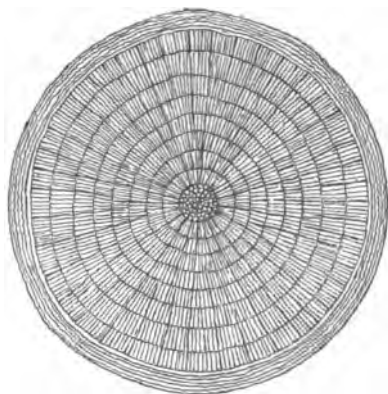

FIG. 1.—Section of an Eight-year-old Oak tree.

different periods of their growth. Soft-wooded trees have usually thick rings; and old trees form thinner rings than young ones. Between the outer ring and the bark, there is a layer of thin-walled cells (shown by a white line in Fig. 1) in which the protoplasm and cell-sap remain, and consequently they are capable of division and growth. This cellular layer is designated the *cambium*: it marks the separation between the wood and the bark, and contains the active formative

tissue of the tree. It constitutes the thickening zone, by means of which the stem is enlarged, the inner cells being subservient to the purposes of wood formation, while the outer cells give origin to the new bark.

While the bark and the pith become, year by year, more and more separated by the intervention of the vascular bundles, the connection between them is kept up by means of processes called *medullary rays* or *plates*. These form the "silver grain" in wood, so conspicuous in oak: they communicate with the pith and the cambium. They consist of cellular tissue, which becomes compressed and flattened so as to form a muriform appearance. In their earliest stage they occupy considerable space, but as the vascular bundles increase they become more and more compressed, forming thin laminæ or plates which separate the woody bundles. On making a transverse section of a stem, the medullary rays will be seen radiating from the centre, or the pith, towards the cambium, in the manner indicated by the radiating lines in Fig. 1. The primary medullary rays extend completely from the pith to the bark; but there are others which only extend through certain of the annual rings, as indicated, and are called secondary rays: these immensely increase the number of rays, adding richness to the figure or silver grain of the wood. The effects produced by the medullary rays depend on the directions in which planks are cut from the stem.

HARD WOODS

OAK (*Quercus*).—There is no hard wood better suited for the use of the amateur joiner, in the construction of such articles of furniture as are depicted in the Plates of this Manual, than good, straight-grained, and richly figured oak. There are several varieties of this valuable wood, some of which are more desirable than others. The oaks are widely distributed over the temperate parts of Europe, Asia, North Africa, and North America.

ENGLISH OAK (*Quercus robur*) is both the most beautiful and durable of all the varieties suitable for joinery, but unless it is thoroughly air-dried and thoroughly seasoned by long exposure it is very liable to warp. We have known boards sawn from beams, taken out of houses more than a hundred years old, to immediately warp to a considerable extent. Thin boards are always liable to warp or twist before or after being dressed.

The colour of English oak is of a pale tawny or brownish-yellow colour; and when cleanly dressed it presents a hard, satin-like surface. When the wood has been properly cut across the medullary rays, a very beautiful display of silver grain is produced under the action of the plane. When very lightly stained and waxed or polished it presents a very rich appearance.

Vast forests of oak covered the greater part of England in the earlier historic period, and the timber they supplied was lavishly used in house and ship-building up to the Tudor period, when the forests had become so seriously reduced that an Act was passed during the reign of Henry VIII. to enforce their preservation. The finest quality of this oak is now by no means common; and is much prized by carvers, especially for articles of church furniture: it works well under the carving tools.

WAINSCOT OAK.—The variety of oak known by this trade name is largely imported from Holland. It is of a pale buff colour, and is generally so cut (“quartered”) as to display a rich silver grain. It is softer and more easily worked than English oak; and on this account, as well as on account of its fine figure, it is to be specially commended to the attention of the amateur joiner. For panels and any large flat surfaces exposed to view, such as table-tops, it leaves nothing to be desired. Plainer wood is preferable for mouldings and surfaces that are much cut up.

AMERICAN OAK (*Quercus alba*).—This wood, commonly known as “white oak,” is largely grown in North America; abounding all over the eastern parts of the continent from Lake Winnipeg and the districts of the St. Lawrence to the shores of the Mexican Gulf. The wood varies considerably in

quality, and this should be kept in mind by the amateur when selecting and purchasing it. Large quantities of this oak are imported from Canada; and it is easily procured in the market at a moderate cost. It is usually straight-grained, and even the best samples are comparatively poor in figure. It is well suited for plain work which is not much in view, such as shelves, backing, and linings. It is quite satisfactory for articles of furniture that are to be stained very dark or of any decided tint.

MAHOGANY (*Swietenia mahogani*).—This well-known wood is of great use to the amateur joiner, lending itself in the most satisfactory manner to all his requirements. The value of mahogany, on account of its beauty, hardness, and evident durability, was first noticed by the carpenter on board Sir Walter Raleigh's ship during his voyage to the West Indies in 1595. Dr. Gibbons brought it into notice as well suited for the construction of furniture in the early part of the eighteenth century; and its use as a suitable cabinet wood was first practically established by a workman named Wollaston, who was employed by Dr. Gibbons to make some articles of furniture of mahogany brought to this country by his brother. Since then no wood has been more generally used for cabinet-making purposes, and none possesses like advantages of combined soundness, large size, uniformity of grain, durability, and beauty

of colour, and, in the choicer varieties, richness of figure.

Mahogany, as furnished by the timber merchant, is classified under two heads; namely, Spanish mahogany, and Honduras mahogany or baywood. The former comprises the close-grained, heavy, and rich varieties of the wood which are capable of receiving a high polish: it may in general be distinguished from inferior wood by its pores containing a white deposit when it is freshly planed. The original Spanish mahogany is the produce of the island of San Domingo; and the finely figured wood is now so valuable as to be used only for veneers. Mahogany imported from Cuba can, however, be obtained in boards suitable for cabinet-making; and the plainer kind will be valuable for any small work the amateur may essay. Honduras mahogany is grown in Central America, and is shipped in the Bay of Honduras, hence its common name, baywood. This variety embraces the light, open-grained, and plain classes of mahogany; uniform in colour and easily worked, and almost devoid of any tendency to warp. Combined with these advantages is its comparative cheapness, placing it within the reach of every amateur joiner likely to use a hard wood.

BLACK WALNUT (*Juglans nigra*).—This is a wood very suitable for cabinet-making; indeed, it has been used to so great an extent for that purpose in the

United States, that it has become scarce and almost as dear as good mahogany. When straight-grained and dry it dresses well, leaving the plane with a firm, silky surface; and it is otherwise easily worked, and glues in a perfectly reliable manner. The colour of the wood is a dark and somewhat dull brown, not particularly pleasing in appearance. But for furniture which is to be ebonised (stained black), black walnut is perhaps more suitable than any other available wood.

TEAK (*Tectona grandis*).—This grand wood should be known to every amateur joiner who aims at artistic work. Fine effects can be produced by its association with pale oak, with which it forms a pleasing contrast of colour. The best wood is of a yellowish-brown tint, and is straight-grained and easily worked. The tree grows to a large size in the forests of India, Burma, and Siam. When once seasoned it neither warps nor cracks; and it contains an aromatic resinous substance which preserves the iron screws which enter it. We strongly recommend it to the attention of the amateur joiner, for it is neither a scarce nor an expensive wood in the market.

TOON (*Cedrela toona*).—This is an Indian wood worthy of the amateur joiner's attention. The tree grows plentifully in Bengal and other districts of India. It grows to an immense size, a single tree having been known to yield 80,000 feet of fine timber. The

wood somewhat resembles mahogany, and is light and durable. It takes a high finish, and is in every way very suitable for furniture and joinery.

JARRAH (*Eucalyptus marginata*).—A wood grown plentifully in Western Australia. It is also known as the “mahogany gum-tree.” The wood is of a reddish-brown colour, heavy, and close-grained: it is easily worked, and receives a high finish under the plane. These important and desirable properties render it very suitable for good joinery.

CEDAR (*Cedrela odorata*).—The West Indian or ordinary red cedar may be considered in joinery as a poor substitute for baywood. Only the hardest and close-grained variety should be selected for work of any importance.

ELM (*Ulmus campestris*).—The common elm is grown in England, Europe, Asia Minor, and North America. The wood in its young state is brownish-white, but becomes, with growth, of a brown colour having a slight greenish tone: it is close-grained, free from knots, and its medullary rays are not visible. In the United States the best elm is largely used for church furniture; and there and elsewhere it is employed in joinery and in cheap cabinet-work. The other varieties of elm are not of great value in joinery.

SOFT WOODS

PINE (*Pinus strobus*).—This fine and valuable North American wood is known in the United States as “white pine,” and in this country as “yellow pine.” It is unsurpassed for joinery where a hard wood is not necessary; and, accordingly, it is of all woods the best for the amateur joiner to commence practice with. It can be easily procured of any required dimensions, perfectly straight-grained, and free from knots or other imperfections; and the finest quality, known as “brights,” should be selected. The wood is light, soft, and easily worked, and glues well. When freshly cut, it is of a pale straw colour, but becomes considerably deeper in tint, inclining to a brownish-yellow, when exposed for some time to light and air. The annual rings are not distinctly marked; but their direction, indicating the manner in which the deal has been cut from the tree, can be distinctly traced. The finest wood has a clear, silky surface when newly planed, and commonly shows short, detached, hair-like streaks running in the direction of the grain, caused by the cutting of the medullary rays. This class of wood is in all respects suited for articles of furniture which are to be painted, or simply varnished and, perhaps, decorated by means of stencilling. It should not be employed for articles subject to hard usage.

YELLOW POPLAR (*Liriodendron tulipifera*).—This variety of poplar, commonly known as “white wood,” is largely used in joinery and the cheaper class of cabinet-work. The colour of the wood varies somewhat, but may be described as a cold yellowish or brownish-white, and the annual rings, being darker on one side than the other, can easily be distinguished. The best quality of this wood is uniform in texture and even in grain; and when thoroughly seasoned and kept dry, it is not very liable, under ordinary atmospheric conditions, to warp, swell, or shrink. While it is in all respects inferior to the best yellow pine, as described above, it is well suited for the amateur joiner’s use, and has the advantage of being comparatively cheap. It is all that can be desired for painted furniture, and it takes stains in a satisfactory manner.

SEQUOIA OR REDWOOD (*Sequoia sempervirens*).—This is a very useful wood in joinery, and deserves the amateur’s attention. The wood is straight-grained, free from knots, and of a brownish-red colour. It is easily worked, taking a fine finish from the plane. The annual rings are boldly marked by dark lines, which latter impart a rich appearance. It can be French-polished, wax-polished, or varnished, and takes ebony or rosewood stain perfectly.

PITCH PINE (*Pinus australis*).—This is the yellow pine of the southern States of America, where it grows

to great perfection in the sandy soils of Georgia, Florida, and the Carolinas. The tall columnar trunk of this tree furnishes a most valuable and oftentimes a very beautiful wood of a pale yellowish colour, which becomes much richer by exposure for some time. When carefully dressed, this wood polishes in the most satisfactory manner. We have found, in the Liverpool timber-yards, pitch pine having an extremely rich figure; and we have used samples which exceeded the finest satin-wood in brilliancy of golden tint and boldness of figure. Pitch pine is much heavier and harder than the pine and poplar described above, and, at the same time, it is not so easy to dress.

There are some soft woods of an inferior quality; but as we cannot recommend them for use by the amateur joiner, it is unnecessary to describe them here.

CHAPTER III
TOOLS AND THEIR USES

CHAPTER III

TOOLS AND THEIR USES

ALTHOUGH it is not likely that any one who seeks the aid of this Manual will be altogether unacquainted with the proper use of the ordinary joiner's tools, it is necessary, in enumerating the several tools that the amateur will require in such work as he is likely to undertake, for us to describe them and their uses sufficiently for all practical purposes. We may remark, however, that it would be highly desirable for the amateur, who is not thoroughly acquainted with the correct manner of holding and manipulating such tools, to seek a few lessons from an experienced joiner, especially in the correct way of using the several saws and planes. We again advise this simple course, because it is practically impossible to teach in words exactly how such tools should be held and applied to secure satisfactory results.

In the following particulars we shall enumerate the full complement of the several kinds of tools necessary for the expeditious execution of good and workmanlike joinery, leaving it to the judgment of the amateur to decide which, and how many, tools

he will require for the class of work he intends to undertake. As his skill and requirements increase, he can add to his equipment until his workshop presents a very complete appearance. As good work can only be executed with good tools, we strongly advise the amateur to purchase those of the best quality; and, above all, to keep them in perfect working condition from the hour in which they are first sharpened and used. A good workman should take as much pride in his tools as in the work they produce.

THE SAW

There are nine saws in common use in the hands of carpenters and joiners, but of these the following

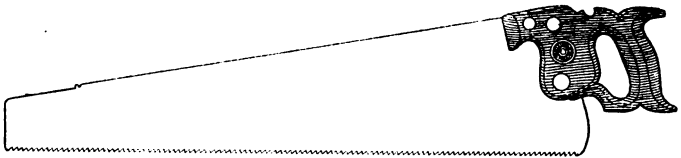

FIG. 2.

are the only ones necessary in the production of such articles of furniture as are illustrated in the Plates of this Manual.

HANDSAW.—This is a saw of the form shown in the accompanying illustration, Fig. 2, measuring $26\frac{1}{2}$ inches in length and having about twenty teeth in every 4 inches. It is properly used for cutting across the grain; but it can be used for “ripping,” or

cutting along the grain, under ordinary conditions. There is a saw, of similar form, specially made for the latter operation, designated the **RIPPER** or **RIPSAW**: it differs from the **HANDSAW** in the shape and set of its teeth. The extent of the set varies according to use to which the saw is put, and the class of wood it is employed to cut: the **HANDSAW** has a greater amount of set than the **RIPPER**; and saws used for hard woods require a smaller amount of set than the ordinary saws used for pine and other soft woods. If the amateur can afford it, we would advise him to obtain both the saws named above.

In using either of the saws, the handle must be gripped firmly with the right hand, so as to control its direction while making its cut. On starting a cut, at a line marked on the wood, the entry of the saw should be guided by a slight pressure of the thumb of the left hand, bearing on the side of the saw just above its teeth. When the cut has been properly started, the thumb can be removed, and the left hand will then be free to hold the wood steady in any required manner. In "ripping" planks or pieces of wood of a few feet in length, a pair of *carpenter's trestles* will be required; and these will allow a knee to be placed on the plank to hold it steady, if necessary, either in ripping or cross-cutting. There is one matter that should be observed; namely, while making a cut, the saw must be allowed to eat its own

way; hardly any pressure should be applied with the view of hastening the operation. In ripping a long plank, it may be found that the cut closes on the saw and prevents its easy action: when this is the case, a thin wedge of wood should be pressed into the end of the cut, so as to open it enough to release the saw. As it is all-important that the amateur should be able to use the saws properly from the first, we may repeat the advice, already given, that he should obtain a few lessons from some experienced workman.

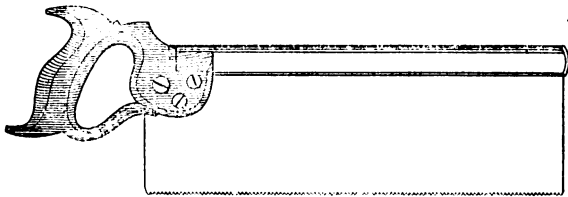

FIG. 3.

TENON-SAW.—This saw, which is of the form shown in Fig. 3, is, as its name implies, commonly used for cutting tenons, but is equally useful for cutting any small work either across or along the grain. It will be seen in the illustration that it has a bar along its back: this is a folded piece of iron or brass, necessary to prevent the saw from buckling while being used. The available blade measures about 14 inches long and 4 inches broad, and has, as a rule, from nine to twelve teeth to the inch. In using this saw, the handle must be

firmly grasped, so as to give full command of the blade while cutting. At the commencement of the cut, the handle end must be held slightly raised, so that the entry of the saw may be made with its front end; after which the blade may be gradually brought to the horizontal position. In cutting a tenon lengthwise, the piece of wood must be fixed vertically in the *bench-vise*. In completing the tenon, by cross-cutting away the side pieces, the piece must be laid flat on the bench, and held against the *bench-stop*, or adjusted to the square cut in a *mitre-box*. The latter is more likely to favour accurate cutting in the hands of an inexperienced amateur. The **TENON-SAW** is properly used in the *mitre-box*. The teeth of this saw have a very slight set.

DOVETAIL-SAW.—This is a saw similar in form to the *tenon-saw*, but of a much smaller size, and having very fine teeth: it commonly measures 8 inches in length and 3 inches in breadth of blade. As its name implies, its chief use is for cutting dovetails for the formation of dovetail joints, as described in the following Chapter. This saw is, at the same time, very useful for cutting small work requiring great accuracy: in this direction it is more convenient than the larger *tenon-saw*. The teeth of the **DOVETAIL-SAW** are extremely fine, and have only sufficient set to prevent the saw being friction-bound in the cut.

COMPASS-SAW.—This is a saw, having a long, narrow, and tapered blade, used for cutting curves of any description, and of a sufficient size to suit the width of the blade. The amateur will find it extremely useful for cutting many of the outlines and perforations shown in the designs given in the Plates of this Manual. There are two other saws somewhat similar in form but different in size; namely,

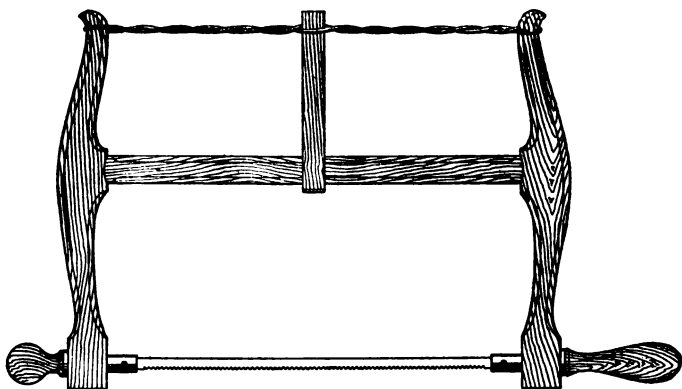

FIG. 4.

the **TABLE-SAW** and the **KEYHOLE-SAW**. In the former the blade is broader and in the latter narrower than that of the **COMPASS-SAW**. The **KEYHOLE-SAW** is, as its name implies, used in cutting small openings.

Bow-SAW.—The usual and convenient form of this tool is shown in the accompanying illustration, Fig. 4. The saw, which is a very thin, narrow, and straight ribbon of steel, very finely toothed, is stretched in a frame, the necessary strain of which

is imparted, by a twisted loop of strong cord, in the simple manner indicated. This saw is very useful in cutting small curves or ornamental openings, which are usually started from a brace-bit hole. To insert the saw, the bow is loosened to allow one end of the blade to be removed from its holder, passed through the hole, again attached to its holder, and strained by the twisting of the cord. When this is done, the blade is turned, by means of its two handles, in the direction required, and the cutting is proceeded with. The bow is held by the larger handle.

For the proper sharpening and setting of saws no directions of a sufficient nature can be given in words: and as a saw can be easily injured, by ignorant hands, in these important matters, the amateur must seek direct instructions from a proficient workman.

THE PLANE

The next important tool to be considered is the **PLANE**. It is absolutely essential in the execution of every finished piece of work the amateur may essay; and the beauty of that work will largely depend on the perfection of its planing, or *dressing* as it is technically called. It is not only necessary that the amateur should possess such planes as the different operations of joinery require, but that he should be

thoroughly acquainted with the proper ways of using them, how to adjust their *cutting-irons*, and how to keep them, generally, in good working order. Each plane should be carefully reserved for the class of work for which it has been designed and is best fitted; and the finer planes should never, to merely save a little time and trouble, be used for rough work. Amateurs are apt to forget that such care is necessary, and only realise it when they find all their planes out of order. The delicate cutting-edges of the finer *irons* are very liable to be notched if roughly and carelessly used, and sometimes this may involve re-grinding in addition to considerable sharpening on the oil-stone. To avoid any accidental injury to the exposed edge of the *iron*, a plane should be laid down on its side in preference to being hastily put down on its sole or face on the bench or any hard surface.

It is very important that the amateur joiner should select for his use the best planes to be found in the market to-day; and these we unhesitatingly affirm to be the Stanley "Bailey" Adjustable Iron Planes, made by the Stanley Rule and Level Company, of New Britain, Connecticut, U.S.A. It is properly claimed that these planes work better than others in any kind of wood; are better made; are made of better materials; and can be better and more easily adjusted. We can say, from long personal experience, that these planes are faultless in every respect. It is well known

that wood planes soon become worn and uneven on their soles or planing-surfaces; and that their mouths become worn too open, caused by the constant friction of the shavings passing through them. Nothing of this kind is possible in the Bailey planes. We have made the drawings given in the following Plate A from a SMOOTHING-PLANE we have long used, so as to enable us to properly describe the construction and manipulation of the Bailey plane. With the exception of the handle A and the left-hand rest B, every part of the plane is made of metal. The principal portion C is of fine cast iron, accurately planed flat and die-square on its sole and two exposed sides. The sides are carried sufficiently high to allow the plane to be used in "shooting." A prominent feature of the plane is its cutter D, which is thin and of uniform thickness: the advantages of which are lightness, ease in grinding, less grinding, as a thin cutter can be kept in good condition by honing, and less liability to "stub off" the cutting-edge when honing; hence the original bevel is retained much longer. The cutter is made of specially tempered English steel. This improved form of cutter renders it unnecessary to detach its cap E at any time, as it will slide back to the extreme end of the slot in the cutter without any danger of falling out. It can then be tightened by a turn of its screw, and the cap will serve as a convenient handle or rest while sharpening

the cutter. The cutter-cap E is made of thin steel, of uniform thickness, curved and ground at its lower end, as indicated, and held to the cutter by the cap-screw F, shown in Fig. 2: these three simple parts constituting what is technically known as the "double-cutter" or "double-iron." The cutter-seat or "frog," shown at G, is adjustable, sliding on a machined seat, raised from the plane bottom at H: its relation to the mouth of the plane, and the manner in which it carries the cutter, and all the fixing and adjusting parts connected therewith, are clearly shown in Figs. 1 and 2. The lever-cap I is held in its place by the screw J, which acts as a fulcrum, and the cap may be rigidly clamped down upon the cutter-cap E by means of the lever-cam K. When the lever-cam is turned upwards and ceases to bear upon the cutter-cap, the lever-cap can be removed and the cutter taken out without turning the screw J, the lever-cap and double-cutter being properly slotted for this purpose. When the cutter is clamped in its place, it can be adjusted accurately lengthwise by means of the adjusting-wheel L, which moves the Y-lever M, the upper end of which engages in a small slot in the cutter-cap, as indicated in Fig. 2. This simple mechanism allows an instant and most minute adjustment of the cutting-edge at the mouth of the plane, without disarranging a single part of the tool. The lateral adjustment of the cutting-edge is effected by means of the lever N,

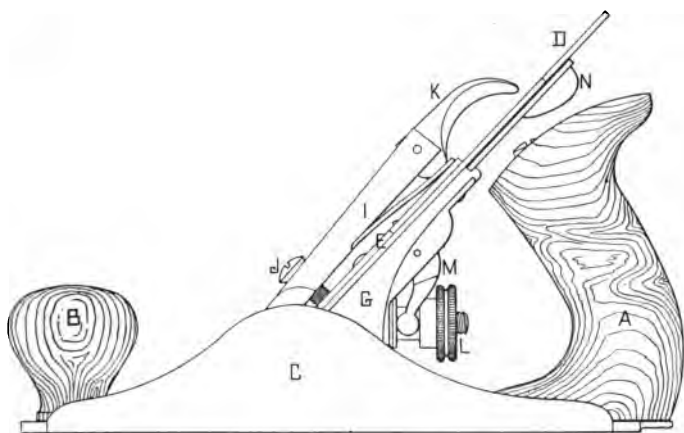

FIG. 1

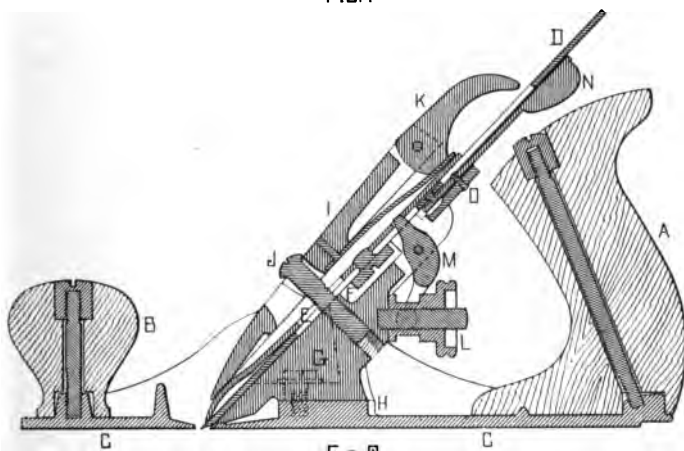

FIG. 2

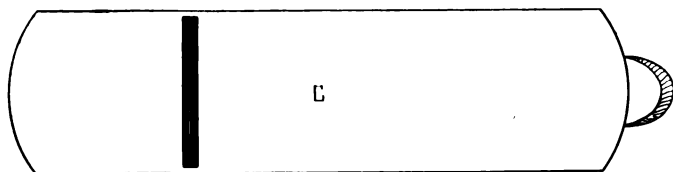

FIG. 3

which is pivoted on the upper part of the cutter-seat at O, in Fig. 2. One end of this lever engages in the slot of the cutter, in the manner indicated, and by moving it laterally, the cutting-edge of the cutter can be easily brought exactly true with the sole of the plane, if the cutter should not be exactly true when clamped down. A revolving disc on the lever N, where it engages in the slot of the cutter, prevents all friction. From this detailed description, the plane might seem to be a complicated tool, while it is in reality beautifully simple in all its parts, and, owing to its perfect workmanship, is manipulated with the greatest ease and certainty.

Of the ordinary flat-soled planes there are four kinds in common use; namely, the JACK-PLANE, SMOOTHING-PLANE, FORE- or TRYING-PLANE, and JOINTER. These may be briefly described.

JACK-PLANE.—This plane is made of two lengths—14 inches and 15 inches—and is furnished with all the fittings and adjustments described above. This plane is used for removing the rough surface left by the saw and preparing the wood for finer dressing. Its cutter is usually slightly rounded toward its corners, so as to allow a considerable bite to be given, by having the cutting-edge sufficiently projected beyond the sole of the plane to enable it to cut well into the rough surface of the wood. This plane is practically indispensable. In using the JACK-PLANE, it is

usual to move it each time an easy arm-length; the shavings removed will, accordingly, be short and somewhat thick, although the latter will depend on the projection given to the cutter. Straight strokes must be made with this plane.

FORE-PLANE.—This plane is 18 inches long, and is the proper one to follow the *jack-plane*. It is used to remove all inequalities left by the latter tool, and to bring the surface of the wood to a true and perfectly level condition. The proper use of the **FORE-PLANE** is essential for the production of satisfactory work. The amateur should take every opportunity of learning how to use this tool. To produce a true surface, the plane must be so applied as to remove a shaving the full length of the wood, for unless this is done inequalities are almost certain to obtain. Under no conditions must the plane be moved in any curving direction: absolutely straight strokes are imperative. The Bailey **FORE-PLANE** is a truly beautiful tool, having all the parts and adjustments already described and illustrated; and, when in good order, works in a way that cannot be calculated upon with any ordinary wood plane in existence: its iron sole never goes out of shape, while a wood plane, as our experience has taught us, is always liable to twist and become useless until dressed true. As in the case of the *jack-plane*, the **FORE- or TRYING-PLANE** is practically indispensable.

SMOOTHING-PLANE.—This is the plane already described, and shown in the drawings given in the preceding Plate. It is made in five lengths—5½, 7, 8, 9, and 10 inches. The plane illustrated is that of 8 inches, and it may be considered the most suitable size for such work as is contemplated in this Manual. This plane, as its name implies, is used for giving a final finish to work as it is left by the *fore-plane*. Like the *fore-plane*, it must be used with long straight strokes. In adjusting the cutter, the cutter-cap (E, in the Plate) must be brought as close as possible to the cutting-edge without completely covering it. Experience will soon show what is necessary in this direction. When the plane is in good order and properly used, it should cut a perfect shaving so thin as to be almost transparent.

JOINER.—The Bailey plane of this name is made of two lengths—22 inches and 24 inches—its rigidity and absolute accuracy rendering it unnecessary to make it as long as the common wood JOINER. Its chief office is the “shooting” of edges of long planks for plain glue-jointing. It will be very rarely used by the amateur joiner, unless he is somewhat experienced, and is engaged on large work requiring broad planks. For short joints of this nature the *fore-plane*, if properly handled, will be found sufficient.¹

¹ The makers of the Bailey Iron Planes claim that their Stanley “Bed Rock” Adjustable Iron Planes “embody a perfection in design

MATCH-PLANE.—This useful tool, in its best form, as made by the Stanley Rule and Level Company, is entirely of iron and steel, and is reversible. It is termed the **DOUBLE-END MATCH-PLANE**; it cuts the tongue with one side, and, by reversing ends, it cuts the groove to match with the other side: it has double handles and all necessary adjustments. It is made in three sizes—for boards $\frac{3}{8}$ inch, $\frac{5}{8}$ inch, and $\frac{7}{8}$ inch thick. This plane is only required in the jointing of match-boarding, such as is used in the back-boarding of the Bookcase shown in Plate IV., and the Dresser shown in Plates XX. and XXI. In using this plane, the boards, previously dressed, have to be securely fixed in the *bench-vise*, and the tongue or groove formed by carefully running the plane along the edge, holding its side-guide closely against the finished face of the board.

BEADING-PLANE.—This plane is used for forming small beads along grooved and tongued joints, as shown in Fig. 22. It may be obtained, in its simplest form, suitable for a bead about one-quarter of an inch in diameter. To produce a clean bead, care must be taken to run the plane with the grain of the wood.

which combines, as the name implies, a construction of the utmost solidity, and with better and more adjustments than any Plane heretofore produced." They are somewhat dearer than the Bailey planes, and this may be a matter of some consideration to many amateurs.

REBATE-PLANE.—This is a useful plane, used for sinking rebates in the edges of boards. We strongly advise the amateur to purchase the Stanley Improved **REBATE-PLANE**: it lies flat on either side, and can be used right or left hand while planing to corners or up against perpendicular surfaces.

MOULDING-PLANE.—There are numerous planes used for running mouldings, but the amateur need only acquire those necessary for his immediate requirements. The advanced workman, who can afford it, should purchase the Stanley Patent Universal “55” Plane. The regular equipment supplied with this plane comprises 52 cutters arranged in four separate wooden cases: an additional set, of 41 special cutters, is regularly made. With the complete line of cutters there is practically no end to the variety of work which can be done with this tool. As the makers say: “No. ‘55’ Plane is 10 inches long, and weighs only $7\frac{3}{4}$ lbs. (with 93 cutters 11 lbs.), and replaces a full line of 93 Fancy Planes weighing probably 90 lbs., thus justifying the name **UNIVERSAL** given it.” It is certainly a tool of marvellous resources. The price of the plane and 52 cutters is £2, 19s. od.

THE CHISEL

The **CHISEL** is an indispensable tool in the hands of the amateur joiner, being more or less used in

every branch, and almost at every step of his work. The make selected should be the **FIRMER-CHISEL**, the form of which is shown in Fig. 5. These are made in sixteen graduated widths, from $\frac{1}{16}$ inch to 2 inches, but the following eight sizes will be sufficient for all ordinary purposes, $\frac{1}{8}$, $\frac{1}{4}$, $\frac{3}{8}$, $\frac{1}{2}$, $\frac{3}{4}$, 1, $1\frac{1}{2}$, and 2 inches. The amateur, in the earlier stages of his operations, will probably find several of these sizes unnecessary; but as such chisels are not expensive articles, he may fairly aim at possessing the suggested selection if not the complete set. He will, of course, purchase the chisels handled and ready for final sharpening. When purchased, the end of each chisel will be found nicely ground, as shown in Fig. 5: the final sharpening must be done on the *oilstone*. This should be done by holding the chisel firmly, at the proper angle, on the oilstone, and moving it forwards and backwards, steadily retaining that angle. The angle should be as acute as the ground slope of the chisel will allow; but care must be taken not to make the cutting-edge too thin to stand fairly rough usage. When a keen and serviceable edge has been found, its angle should be always retained in subsequent sharpenings.¹

MORTISING CHISEL.—Two forms of this chisel are shown in Fig. 6. The larger one is suitable

¹ There are several mechanical devices to assist in sharpening chisels and plane-irons: these can be obtained at any tool shop.



FIG. 5.



FIG. 6.



FIG. 7.

for deep mortises, and is driven with a *mallet*, while held vertically to the surface of the wood. It is made of different widths to suit the size of the required mortise. The small one is suitable for cutting out or clearing small mortises which may have been previously bored in the manner indicated in Fig. 26. It may not require the application of the *mallet* unless it has to cut the mortise entirely itself, and in some hard wood.

THE GOUGE

This is a chisel with a segmental cutting-edge, and of the form shown in Fig. 7. This tool is sharpened in two ways; namely, with the ground slope outside, as indicated in the Figure, or inside. When required for cutting hollows or grooves, the outside-ground GOUGE must be employed: but when required for paring any curved perforation, the inside-ground GOUGE must be used. Like the chisel, the GOUGE is made in several widths; and, in addition, it is formed to arcs of circles of different radii.

THE BRACE AND BITS

As the amateur joiner will have to use the BRACE and BITS very frequently in the construction of numerous articles of furniture which are within his powers, he should be careful to procure them of good quality, selecting a BRACE that works easily and is

fitted with ready means of receiving and tightly holding the BITS. The form of the BRACE illustrated in Fig. 8 is in every way satisfactory: its easy working is secured by the ball-bearing in its head (indicated in the small section) and the easy fitting of its handle. It is also furnished with ratchet gear on the spindle, which permits the tool to be used in confined positions where the entire sweep cannot be made: the con-

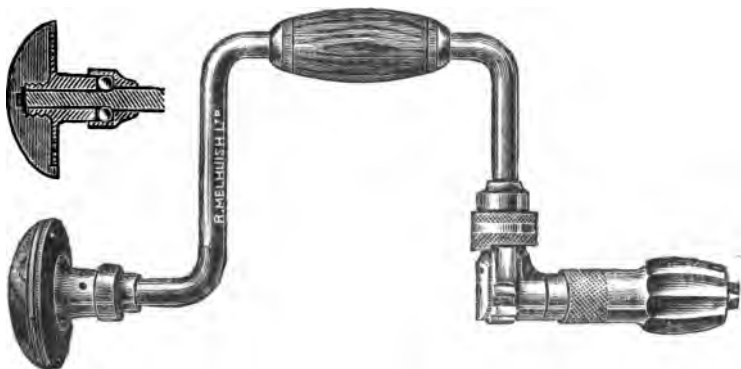

FIG. 8.

venience of this the amateur joiner will quickly realise. We strongly recommend the Stanley Box Ratchet BRACE, No. 919, having a 10-inch sweep. In addition to its chief use in boring, the BRACE is a valuable tool when employed as a screwdriver, especially when numerous screws have to be driven. By its use in this direction much time and labour are saved. The BRACE recommended above costs about six shillings. A non-ratchet one of similar quality can be purchased for about five shillings.

BRACE BITS.—The amateur should procure a set of C. E. Jennings' twist BITS, which are made in graduated sizes—from $\frac{1}{4}$ inch to 1 inch. The accompanying illustration, Fig. 9, shows a set of eleven

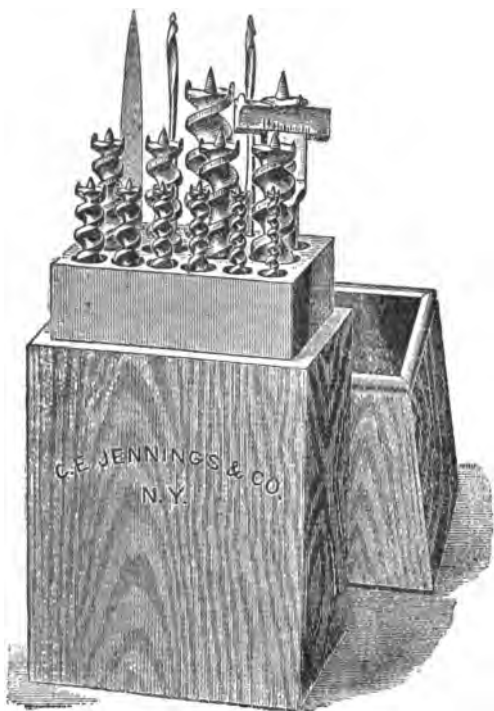

FIG. 9.

of these BITS, up to one inch in diameter; a Clarke expansive BIT; two special gimlet BITS; and a sharpening *file*: all are conveniently contained in a wooden case, and, accordingly, are preserved from injury. In addition, the amateur should obtain

three or four spoon BITS, a countersink BIT, and a screw-driver BIT, all of which will be found to be practically indispensable.

The boring tools should be completed by the



FIG. 10.

addition of three or four GIMLETS, of different sizes, and of the twist pattern shown in Fig. 10; and three BRAD-AWLS of different sizes, and of the best quality.

THE GAUGE

TWO GAUGES are absolutely necessary; namely the MARKING-GAUGE and the MORTISE-GAUGE.

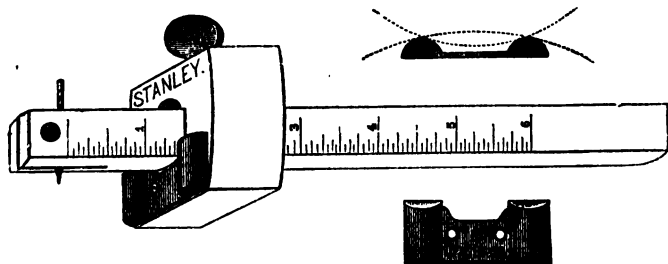

FIG. 11.

The best shape of the former is shown in Fig. 11. It is the Stanley GAUGE, No. 165; and has, in addition

to its scale of six inches, which enables its marking-point to be accurately set to any dimension (when the position of its head is reversed), a most ingenious appliance which enables it to be used on convex or concave edges: the small section, with the dotted lines, shows how this is accomplished. The MORTISE-GAUGE is shown in Fig. 12. It has one fixed and one movable marking-point, enabling it to be set to the width of the mortise, and to the distance of the



FIG. 12.

same from the edge of the piece to be mortised. The Stanley GAUGE, No. 71, combines both the single-marking and the double-marking tools, being furnished with two sliding bars, one of which is graduated in inches: this is a very complete and handy tool.

THE SQUARE

TRY-SQUARE.—This handy tool is absolutely indispensable, being called into play at almost every stage of the simplest woodworking processes. It is shown in Fig. 13. It is desirable that the amateur joiner should possess two SQUARES, one having a blade

4 inches long, for ordinary edge-squaring and small work, and the other, having a blade 12 inches long,

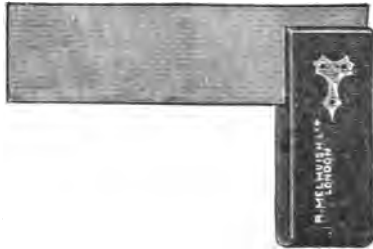

FIG. 13.

for squaring and marking planks or broad surfaces and ends.

MITRE-SQUARE.—This tool, shown in Fig. 14, is also of great use in marking and testing mitre joints. Though not indispensable to the joiner who

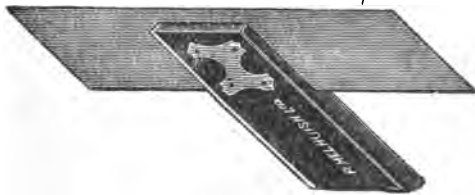

FIG. 14.

possesses a *mitre-box* and *mitre shooting-board*, it is a very desirable tool when accurate work is aimed at. It is very useful in marking angles of 45° correctly. The **MARKING-AWL**, shown in Fig. 15, is a desirable tool to use with the **SQUARES**; and, indeed, for general marking purposes.

In addition to the more important tools described



FIG. 15.

above, the following ordinary tools will be required, which call for no description :

TWO HAMMERS—one large and one small.

TWO SCREWDRIVERS—one medium and one small.

ONE MALLET—of medium weight.

ONE RULE—two feet long.

ONE STRAIGHTEDGE—preferably of steel, about two feet long.

ONE OILSTONE—large size “ Washita ” or “ India. ”

ONE SPOKESHAVE—small, with straight cutter.

ONE GLUE-POT—copper, one-pint size.

It is, of course, understood that the amateur is provided with a properly appointed joiner's bench, not less than four feet in length ; and, in addition to it, the following simple appliances will be found practically indispensable. These can be easily procured ready made ; but if the amateur is skilled in the use of the saws and planes he can readily construct them. To enable him to do so, we give the accompanying illustrations, briefly describing the same.

SHOOTING-BOARD.—This consists of two carefully dressed pine boards, one fastened on the face of the

other in the manner indicated in Fig. 16. The lower board projects 4 inches in advance of the edge of the upper, so as to form the bed for the *shooting-plane* to rest upon. The upper board, about 9 inches broad, is furnished with a stop, against which the wood rests while its edge is being "shot." Simple as this appliance is, it is very convenient, enabling an edge to be dressed perfectly straight and square. In the process of shooting an edge, the board is firmly held by the left hand against the stop, and with its edge projecting about $\frac{1}{32}$ inch; then the *shooting-plane* (usually the *fore-plane*), laid on its side, is moved steadily along its bed by the right hand cutting in its progress a shaving from the projecting edge of the board. This is repeated until its edge is brought to the edge of the SHOOTING-BOARD, when it will be found straight and die-square. A little practice will make this simple process both easy and certain; and the amateur will find it of great assistance in all branches of his work. The SHOOTING-BOARD may be made of any length, but should not be less than three feet.

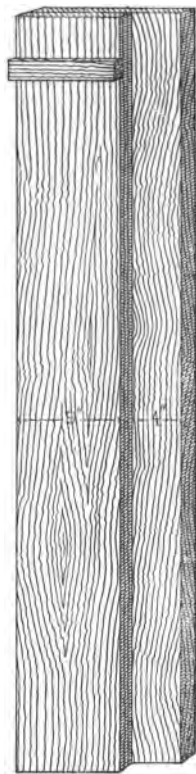

FIG. 16.

MITRE-BOX.—This is another simple and very convenient appliance, enabling the amateur to saw mitres with ease and accuracy. Its common form is shown in Fig. 17, which is drawn in perspective so as to indicate its simple construction. It is formed of a bottom and two side pieces of wood screwed together, as indicated. Across the top edges of the side pieces lines are scratched with the *marking-point*

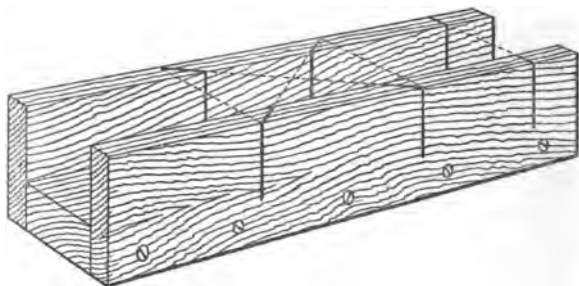

FIG. 17.

and the *try-square*, at a distance apart exactly equal to the outside width of the box; and between the outer points of these lines diagonal lines are marked in the manner indicated by the dotted lines in the illustration. The setting-out is completed by carrying down, from the same outside points, vertical lines on the outside faces of the side pieces. When all the lines have been accurately marked, clean cuts have to be made with the *tenon-saw* along the diagonal and vertical lines, and across the box. These cuts, which are shown by solid black lines in the illustration,

subsequently serve as guides for the saw in cutting a mitre end on any piece of wood laid in the box and held firmly against its off side. The cross cuts are required for the production of right and left mitres. The vertical cuts, shown near the end of the MITRE-BOX, are guides for the saw in cutting die-square ends.

MITRE SHOOTING-BOARD.—This is a necessary adjunct to the *mitre-box*, being used to accurately

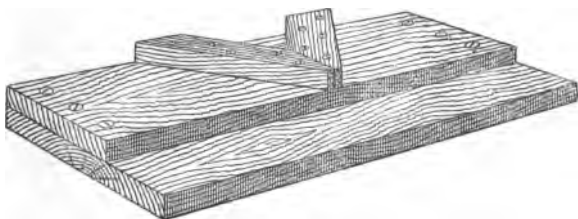

FIG. 18.

dress the ends of the pieces cut by the saw in the mitre-box. A convenient form of this is shown in Fig. 18, and so clearly as to require no detailed description. It is constructed on the same lines as already described in connection with the straight shooting-board, Fig. 16, the only difference being that in the MITRE SHOOTING-BOARD there are two stops, set at the angle of 45° to the shooting edge. This board need not be above two feet in length.

THE CRAMP.—It will frequently be found necessary to tightly press or “cramp” pieces of

wood together that may have been mortised and tenoned, grooved and tongued, or simply glued: we, accordingly, give a drawing of a serviceable cramp, Fig. 19, which the amateur can make of any desirable size. He will only have to purchase the screw and nut-head. Diagram 1 is a side view, showing the wood screw A, the nut-head of which, B, is securely mortised and tenoned to the bar C. The screw moves the sliding block D. At E is the stop-block, which can be roughly adjusted to the work to be cramped before pressure from the screw is applied. A bent loop, of $\frac{3}{16}$ -inch iron rod, holds the stop-block securely against any possible pressure; and is released from, or fixed in the notches in the under edge of, the bar C, in the manner clearly shown. The

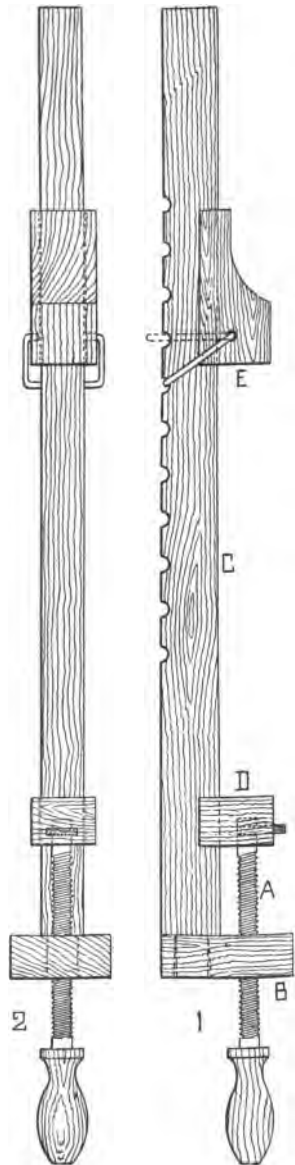

FIG. 19.

CRAMP should be made of oak. The amateur will find it worth his while to make several such CRAMPS of different lengths, varying from 18 inches to 4 feet; the sizes of their several parts being made proportionate. Occasionally two or more may be required on the same piece of work at the same time.

For very rough work, in which great pressure is necessary, iron CRAMPS must be used. These can be purchased at reasonable prices, of any size and of various forms.

CHAPTER IV
METHODS OF CONSTRUCTION

CHAPTER IV

METHODS OF CONSTRUCTION

HAVING, in the preceding Chapter, described, at sufficient length, the several tools which are absolutely necessary for the satisfactory execution of such joinery and cabinet-work as are contemplated in the present Manual, and illustrated in its several Plates; and having given such instructions for the proper use of the tools as the amateur joiner may, under ordinary circumstances, require, we can now direct the amateur's attention to the methods and forms of construction he will have to adopt in his practice of joinery.

Joinery may be defined as the art of putting together, by means of suitable jointing, the several pieces of wood necessary for the formation of any article of utility. It is, accordingly, an art which deserves the attention of every one of domestic habits, who is capable of undergoing a moderate amount of physical exertion, and who possesses some degree of manual skill. It may be described as a clean art, and one that can be practised in any spare room or dry cellar in a house; shavings and sawdust

being practically all that have to be cleared away from time to time. In the event of the practice of the art assuming the importance of a serious hobby, we would strongly advise the amateur joiner to erect a small workshop in any convenient spot in his yard or garden; care being taken to have it so constructed as to be perfectly dry in all seasons; and to possess ample window-space, a good stove for general heating, warming glue, &c., and sufficient means of artificial lighting. The dimensions of the workshop will depend on the class and size of the work to be carried on therein, and this matter should be well considered. If any mistake is to be made, let it be in making the workshop too large rather than too small. It is highly probable that a lathe will be found desirable, if not necessary, in addition to the joiner's bench, and both good light and sufficient space must be provided for it.

One of the simpler methods of joining two pieces of wood is that known as *halving*. Two forms of halving are shown in the accompanying illustration, Fig. 20: that at A shows the method of joining the ends of two pieces of wood, while that at B shows the joining of the end of one piece to any part in the length of another piece. In the process of halving, the single *marking-gauge* must be set to the exact depth required for the joint, which is usually half the thickness of the pieces to be joined, and the necessary

lines scratched on both the pieces where required: then the cross lines must be marked accurately by the aid of the *try-square*. When all the marking has

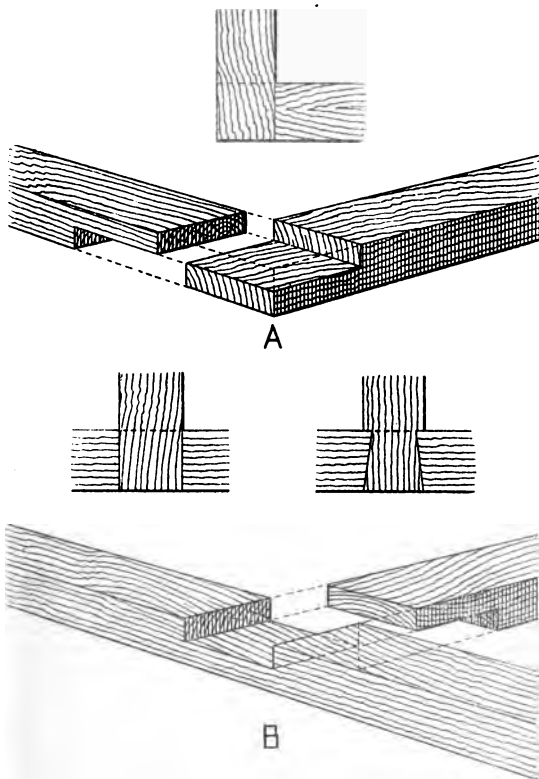

FIG. 20.

been executed, the portions so marked must be carefully cut out with the *tenon-saw*. The end portions at A can be entirely removed with the saw, only requiring two cuts each; but the portion cut

from the lower piece at B, after having its side cuts made with the saw, must be removed with a broad *firmer-chisel*, and its bottom pared perfectly level and true to the gauge marks on both sides.

Great care must be taken to make the halved portions fit accurately; and it will be desirable for the amateur to saw on the safe side of the scratched lines, so as to admit of paring with the chisel in case the joints require adjustment: this is especially desirable in the sinking at B. In completing the joints, they can be simply glued, or further strengthened by being pinned with wood or screwed. In the form of halving shown at B, the joint may assume the form of a *dovetail*, as indicated above: this makes a more satisfactory joint should there be any pull on it.

In Fig. 21 are shown two other forms of halving which the amateur joiner will find useful in the construction of simple pieces of furniture, examples of which appear in some of the Plates in the present Manual. At A and B are shown two thin and deep bars of wood, halved at their edges so as to cross at right angles. In forming this joint the *marking-gauge* and *try-square* must be used as described above; and the sides only of the openings are to be cut with the *tenon-saw*, and the wood removed with a *firmer-chisel*, and all carefully pared, so as to secure a tight and true joint. This form of halving is required in the bars carrying the top of the table shown in Plate VIII.

At C and D are shown two thin and broad bars of wood cross-halved on their sides. In this case the saw has only very shallow cuts to make, while the principal work has to be done with a broad chisel. This is

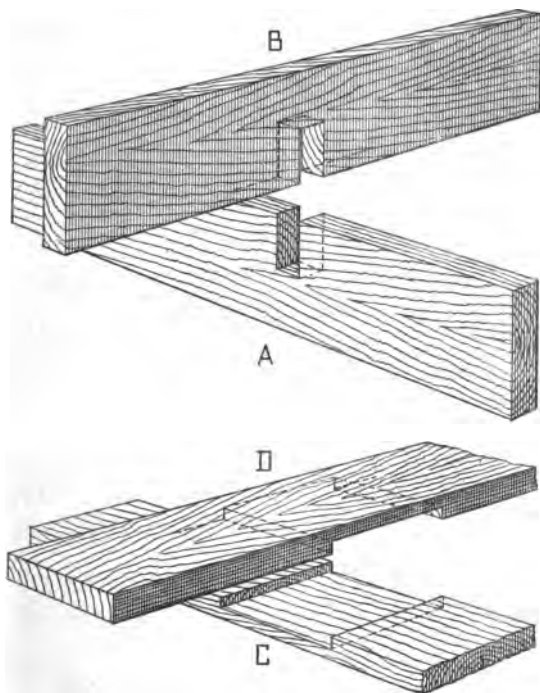

FIG. 21.

also a useful mode of forming flush cross-bars, of which the amateur can make good use in much of his work: it has to be followed in forming the ornamental cross stay-bar in the lower part of the small table shown in Plate VIII., in which the halving

occupies the square, central portion. If the jointings have been carefully and tightly made, glue will be found sufficient, and screwing will rarely have to be added.

Although halving at right angles is alone illustrated in Figs. 20 and 21, it must be understood that halving at any other required angle may be easily executed; a special *mitre-square* (which can be adjusted to any angle) being used instead of the *try-square* in preparing the guide-lines for the saw cuts.

In Fig. 22 is shown the method of jointing



FIG. 22.

by the process known as *grooving and tonguing*. This method is resorted to for joining boards, of any required length, along their edges; such as are required for the back-boarding necessary in such pieces of furniture as bookcases, cupboards, and the like, in which it is not prominently shown. It may, however, be used, when cleanly dressed and beaded (as indicated in the illustration), for the exposed backing of any large piece of furniture, such as in the upper or dresser portion of the sideboard illustrated in Plates XX. and XXI. In this case the boarding should be of the same wood as the rest of the work.

In grooving and tonguing in the manner shown in Fig. 22, special *match-planes* are required. These planes go in pairs, one forming the tongue, by cutting away, to a fixed extent, the wood on each side of it, and the other sinking the groove to receive the tongue.

It is usual to give such match-boarding a neat appearance by beading one edge of each board adjoining its tongue, as indicated in the illustration: this is done

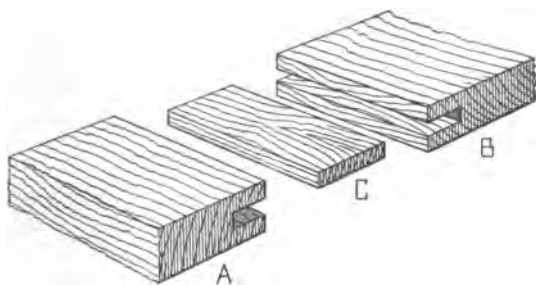

FIG. 23.

with a *bead-plane*. When match-boarding is not in a position to be seen, it is unnecessary to bead it.

In the accompanying illustration, Fig. 23, is shown another method of forming a joint by the process of grooving and tonguing, which differs somewhat from that previously described and illustrated. In this method both the pieces that are to be joined are grooved in the manner indicated at A and B, while the tongue is formed of a separate piece of wood, dressed to the thickness and width necessary to tightly fit into, and completely fill up, both the grooves, but

allowing the joint to be brought absolutely close in the process of gluing. This tongue is shown at C. The tongue is indicated with its grain running longitudinally; but when the joint is not a very long one, and great strength is required, it is advisable to use a tongue with its grain in the transverse direction: it may also be desirable to make it of some very tough hard wood, such as oak or ash. In sinking the grooves the plane called the *plough* will be required.

When the joint is to be completed, very hot glue (not very thick) must be used; and the boards should be pressed together between clamps until dry. Care must be taken to see that the boards go together perfectly flat with respect to each other.

The simplest method of joining boards together along their edges is by means of the *square joint*, or what may be called the plain glue-joint. To prepare the boards for this joint, place them face to face, with their edges exactly level and their grains running in the same direction, and fix them tightly in the *bench-vise*. Then "shoot" both their edges at the same time; in other words, plane them perfectly straight and square. This is best done by the long plane called the *jointer*, described in the preceding Chapter. When the edges are deemed perfectly straight, and found square, by the application of the *try-square* all along them, the boards must be removed from the vise, and their edges laid together and carefully examined to see

that they lie in close contact throughout their length. They can be easily tested by holding them up between the eye and the light: if no light can be seen between their edges the joint is satisfactory. To complete the joint, fix one board, edge up, in the *bench-vise*, and quickly brush its edge all over with very hot, freshly made glue (not too thick but of good body); then lay the edge of the other board upon it, and move it

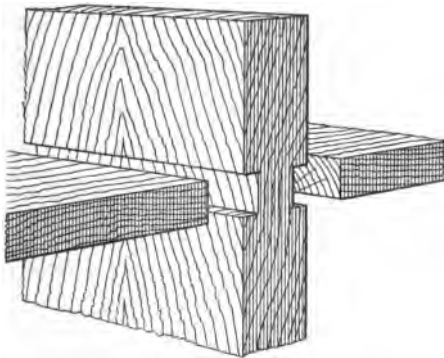

FIG. 24.

forwards and backwards until the surplus glue is worked out from the joint. When the boards are long, both their edges should be brushed with the hot glue.

In the accompanying illustration, Fig. 24, is shown the simple method of jointing shelves or other horizontal portions of a piece of furniture to any vertical portion of the same. This jointing, although shown on both sides of the vertical portion, is usually called for on one side only.

The easiest way for the amateur joiner to execute this joint, seeing that it is probable his command of tools will be limited, may be described as follows: When the exact position and width of the required groove in the vertical portion have been carefully marked, by the aid of a *try-square* of the necessary size, a sharp-pointed knife is taken, and while the square is firmly held against the marked lines, deep cuts must be made, the knife being held at right angles to the surface of the board, which, of course, is laid flat on the bench. The square being laid aside, the knife should be further used to make the cuts as deep as possible. When this has been done, a *firmer-chisel*, a little narrower than the width between the cuts, must be taken, and the wood carefully pared away along the groove, to the depth of the cuts made by the knife. Fresh cuts must be made along the lines of the first ones, and the wood removed until the groove is brought to its required depth. The groove should be so gauged as to receive the shelf or board sufficiently tight to require some force to drive it in.

If preferred, after the first knife-cuts have been made, the sides of the groove can be cut down to their requisite depth with the *tenon-saw*, the wood being removed with the *firmer-chisel*, as directed above.

The diagrams given in Fig. 25 illustrate the method of forming the joint known as the *mortise and tenon*. This is a joint in common use, being required

in the construction of almost every important article of household furniture. Certain articles, such as chairs, may have no other class of joint used in their formation. In preparing for this joint, first true up both the pieces of wood, indicated at A and B, dressing them to within a shaving or two of their finished thickness; and then, with the *mortise-gauge*,

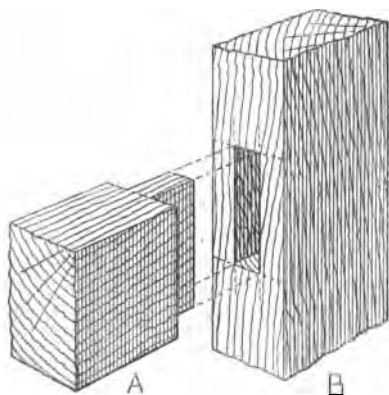

FIG. 25.

set to the thickness of the tenon and its distance from the face of the pieces, mark the end of the tenon-piece and the side of the piece to be mortised; and then with the *try-square* cross-line both, as indicated by the dotted lines, defining the length of the mortise in the one case and the length of the tenon in the other. The thickness of the tenon will vary according to circumstances, but, as a rule, in ordinary joinery, it is equal to one-third of the thickness of the material

on which it is formed. To cut the tenon, fix the piece A in the *bench-vise*, vertically, and carefully saw down with the grain, with the *tenon-saw*, to form the sides of the tenon. Finish each side-cut accurately at the cross-lines, and remove the piece from the vise and saw on the cross-lines, removing the two side pieces. At this stage, the end of the piece

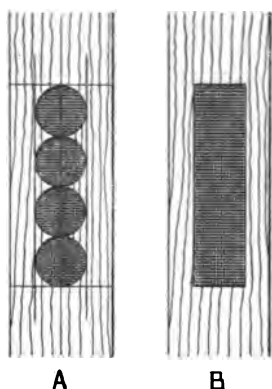

FIG. 26.

assumes the shape indicated at A. The mortise is usually sunk by means of a *mortise-chisel*, a trifle less in width than the width of the mortise: this is applied so as to cut across the grain or fibres of the wood, and is driven into the wood with a *mallet*. The sides and ends of the mortise are finally trued and cleaned with broad and narrow *firmer-chisels*.

Should the amateur not be provided with a proper *mortise-chisel*, he can readily form the mortise in the manner shown in Fig. 26. That is, after he has gauged and cross-lined the wood, he can bore, with a *Jennings' twist bit*, a series of holes as closely together as practicable, as indicated at A, and of the required depth. When this is done, the rest of the wood can be easily removed with *firmer-chisels*, and the mortise finished to receive the tenon. It is highly probable

that this easy and expeditious method of mortising will be generally adopted by amateurs who have not had experience in the use of the *mortise-chisel* and *mallet*.

When the mortise has been formed, the tenon should be inserted and the condition of the joint examined, and tested in all directions with the *try-square*. If it does not fit closely or squarely, the tenon must be withdrawn and any necessary paring executed with a *firmer-chisel*. When satisfactory, both the mortise and tenon must be well coated with hot glue and the joint hammered or clamped tight and true. The surplus glue should be wiped off with a rag or sponge dipped in hot water, and the joint allowed to dry.

In some styles of furniture the mortise and tenon joint is made a more or less effective feature, usually after the fashion shown in the accompanying illustration, Fig. 27. This style of jointing was prevalent in mediæval times, when articles of furniture were constructed strongly and without the aid of glue and screws—now such convenient things in the operations of the amateur joiner. The form of jointing now under consideration can be employed to-day in a certain common-sense class of designs, notably those of a mediæval character, and generally with quite an artistic effect; and it has the advantage of being thoroughly practical and serviceable. This

method of jointing will be found shown in Plates I., II., VI., VIII., and XV.

In Fig. 27 the manner of forming the tenons is indicated by the dotted lines, which extend, and show the form of, the end of the horizontal piece A.

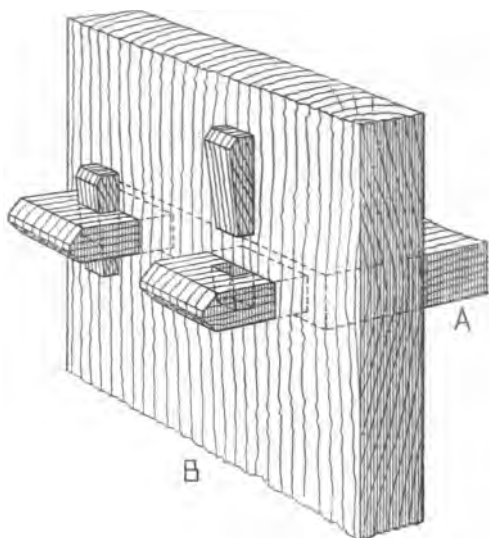

FIG. 27.

When this horizontal piece is sufficiently thin it will not be necessary to reduce it in the tenons, in the manner indicated by the dotted lines. Except in very heavy work, it is not desirable to have the tenons above three-quarters of an inch in thickness. In forming the tenon, it must be carefully dressed on all its sides, and shaped in any desirable fashion at its end: simple chamfers produce a good effect,

as shown in the illustration. The manner in which the tenon must be perforated for the reception of the holding-wedge is clearly shown. The perforation must have a slight inclination in front, to accord with the slope of the wedge, and it should be carried slightly within the face of the vertical piece B, so as to allow the wedge to pull the joint absolutely tight. The wedge should always be made of some very hard wood, such as ebony or rosewood: this is desirable on both practical and artistic grounds. The wedge should, at first, be made longer than is necessary; and when driven tight in the tenon and against the face of the piece B, it should be marked on both sides of the tenon, and subsequently cut to the desired length and cleanly finished at its ends. The mortise must be very accurately and cleanly cut through from the face of the piece B, so as to avoid any chipping of its exposed front edges. When properly formed, this joint requires no glue, but it may be applied if deemed desirable. It may be added that the mortise must not be glued; and no glue should be laid on the exposed portion of the tenon.

We now come to the consideration of the method of corner-jointing known as the *dovetail*; but, on account of the trouble and difficulty attending its satisfactory execution, it is not likely to be much resorted to by the amateur joiner. Under this conviction, we have entirely avoided introducing the joint

in the construction of the articles of furniture represented in the plates given in this Manual. At the same time, it must be acknowledged that no treatise on joinery, however elementary, would be passable without containing some instructions in the methods of forming the dovetail joint. In the illustrations here given, Fig. 28, are shown the two treatments of

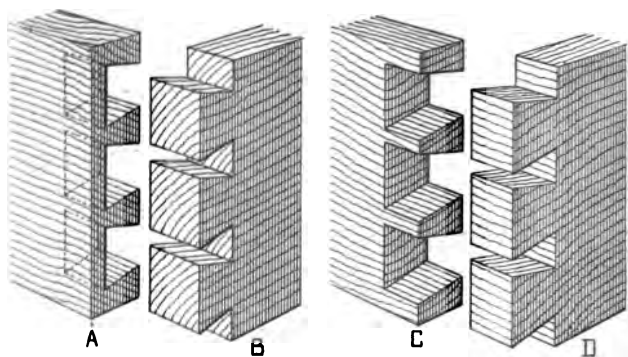

FIG. 28.

the joint in ordinary use. That represented, in its divided state, in diagrams A and B is designated the *lap-dovetail*, which shows when complete the jointing on one side only: and that represented, in a similarly divided state, in diagrams C and D is the *common-dovetail*, which displays its construction on both sides of the corner. The lap-dovetail joint is invariably used in the fronts of properly made drawers or articles of a similar and well-finished character. The common-dovetail is used where strength is required

and appearance is of less importance: it is quite suitable if closely made for work that is to be painted. It may be said, however, that from an artistic point of view, and when the display of truthful construction is desired, there is nothing to be said against carefully made dovetail joints of this common form. This form may be described first. When the boards to be dovetailed have been dressed to the required thickness, and their ends properly planed true and square, a *marking-gauge* must be set so as to scratch a light line along each side of the ends of both pieces, about a twentieth of an inch farther from their edges than the thickness of the wood: this excess is to allow a final dressing off when the joint has been glued. The next process is to carefully draw on the piece D the forms of the dovetails, setting out the measurements uniformly, and using a *try-square* and an adjustable *mitre-square* in marking the lines for the saw-cuts. When this has been done, the piece must be fixed vertically in the *bench-vise*, and the cuts accurately made with the *dovetail-saw*, down to the gauge marks on both sides. The piece must now be removed from the vise, laid flat, and the proper portions cut out with a small *firmer-chisel*. Should any irregularities obtain where sawn, they must be pared true with a chisel. The other piece of wood (which has to be cut as shown at C) must now be fixed in the *bench-vise*, with its edge about level with the top surface of

the bench, and the dovetailed end of the piece D laid accurately in position upon it. The shapes of all the dovetails must now be closely scratched on the end of the uncut piece with a sharp *marking-awl*. When all the additional lines have been scratched, down to the gauge marks on both sides, using the *try-square* as a guide, the cuts may be made, and the larger pieces removed with a *firmer-chisel*. Care must be taken in sawing to keep free of the dovetail lines scratched on the end of the piece, otherwise a loose joint may be made, without any means of altering it: on the other hand, a too tight joint can very easily be put right with the chisel.

In forming the *lap-dovetail* joint exactly the same process must be adopted in forming the end of the piece B as described above in connection with the piece D, with this exception, that the gauge marks must be made at a distance from its edges equal to the thickness of the piece A, *less* the thickness of its lap, as clearly indicated in the diagram. The same gauge that marked the depth of the cuttings in the piece B must now be drawn along the end of the piece A, so as to define its lap, and the limit of its dovetail sinkings. The finished dovetails of the piece B must be accurately adjusted upon the end of the piece A, and their forms scratched thereon, in the manner already described for the piece C. After scratching the inner straight lines of the sinkings,

down to a gauge-line marking the depth of the sinkings, a trifle more than the thickness of the piece B, the sinkings (or "pockets," as they are sometimes called) can be cut out. A certain amount of the cutting may be done with the *dovetail-saw*, but the chief amount must be done with *firmer-chisels*, care being taken to secure a neat and tight joint. Glue both pieces, and gently drive the joint tight, using a piece of flat board between the hammer and the joint. When the glue is dry, the end of the piece A must be carefully dressed off flush with the face of the piece B.

We may conclude our description of the several methods of jointing with directions for the formation of *mitre-joints*. Two of the common modes are shown in the diagrams in Fig. 29. At A, B, and C are shown the forms (in perspective) of the three portions required to construct a *feathered mitre-joint*. The ends of the pieces A and B have to be accurately cut at the angle of 45° . This can be readily done with the *dovetail-saw* and a *mitre-box*. For rough work, the ends as left by the saw will be sufficient; but for fine work, the ends should be shot perfectly true with the *trying-plane*, laid on its side on a *mitre-block*, against which the wood can be held at the true angle. The cut ends of the pieces A and B should be laid tightly together between two flat pieces of wood, and fixed in the *bench-vise*, and saw-cuts made

across the joint to receive the feather-piece shown at C. Where great strength is required, the feather should be of a substantial thickness, as indicated; and in this case two saw-cuts will be necessary, and the wood between them must be removed. In light work, the feather need not be more than sufficient to fill a single thick saw-cut. Some hard wood

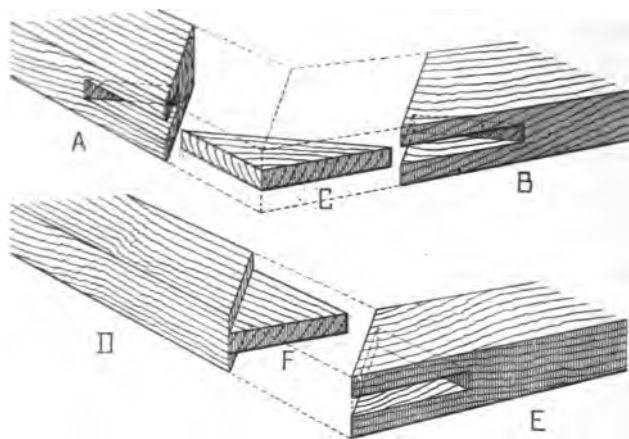

FIG. 29.

veneer is commonly used for this purpose. In all cases the grain of the feather should run in the direction indicated at C.

At D, E, and F are shown the forms of the pieces required in the construction of the *mortise and tenon mitre-joint*. This joint is so clearly indicated as to call for no detailed description. It will be seen that the tenon F, cut at the angle of 45° , at the end

of the piece D, takes the place of an independent feather: this fits tightly into the open mortise in the mitred end of the piece E.

The descriptions and illustrations given in this Chapter practically cover all the modes of jointing that the amateur joiner will be likely to use even in his most ambitious essays in artistic joinery.

CHAPTER V
DESCRIPTION OF THE PLATES

CHAPTER V

DESCRIPTION OF THE PLATES

ALTHOUGH all the articles of furniture shown in the Plates in this Manual are accurately drawn to scale, and are accompanied by their respective scales ; and although practically nothing is left to the imagination, either in details of construction or matters of form, it is desirable, for the further assistance of the tyro in joinery and cabinet-work, that a brief description of each article illustrated be given, defining its nature, and pointing out any peculiarities which may obtain in its formation, which might not occur to him on a mere examination of the drawings. In addition, suggestions respecting the most suitable woods to use in constructing the several articles, and for finishing the same in different ways cannot but be helpful to him.

A HANGING BOOKCASE

PLATE I.—The article of furniture which forms the subject of this Plate is one of everyday utility, and is extremely simple in its construction. A neat, hanging bookcase is very useful in a small room in

which floor-space is much in demand; it is also convenient in a boy's or girl's bedroom, holding a small library of lesson-books, works of reference, gift-books, &c. According to the dimensions shown in the drawing, the two shelves will hold between fifty and sixty books of average thickness. The shelves are 2 ft. 6 ins. long; but they can be made any desirable length from that shown down to 1 ft. 6 ins. Fig. 1 is the front of the bookcase, showing its appearance as placed against a wall, and the simple manner in which the shelves are tenoned through the sides and secured by small wedges. The positions of the tenons are shown in Fig. 2, which is the design of the ends of the bookcase. Fig. 3 is an alternate design for the ends: it is shown chamfered along its edges, but, as this entails considerable labour, the edges may be left square, as in the other design. Fig. 4 is a vertical section through the centre of the bookcase, showing the shelves and the construction of the back, the boarding of which may be about $\frac{3}{8}$ inch thick. The shelves to be $\frac{5}{8}$ inch thick, and the ends, bottom, and top pieces, shaped as shown, to be $\frac{7}{8}$ inch thick.

The best wood for this piece of furniture is plain oak, which can be left in the natural wood, or stained and wax-polished. Baywood is also suitable, which may be ebonised, or stained rich mahogany colour, and varnished and rubbed down. When economy is necessary, good pitch pine can be used, simply varnished.

DUTCH HANGING PLATE-RACK

PLATE II.—The plate-rack illustrated in this Plate is intended to be attached to a living-room wall when a complete dresser is not provided. It is a neat and very convenient article. It is fitted with three grooved plate shelves A, A, A, and a shelf B, on which any standing vessels can be placed. In advance of, and above, the second and third shelves, and directly above the front edge of the first shelf, are the plate-rests C, C, C. When the plates or dishes are placed in the rack, their edges lie in the grooves in the shelves, while they incline forward against the rests. This position allows the plates to be readily placed and removed. Fig. 1 shows the front of one end portion of the rack; and Fig. 2 is a vertical section of the same, showing the grooved shelves, the three plate-rests, and the form of the end boards, which are grooved to receive the ends of the shelves, and mortised to receive the tenons of the plate-rests. The construction is extremely simple, as indicated by the dotted lines in Fig. 1. The ends to be $\frac{7}{8}$ inch thick; the shelves $\frac{3}{4}$ inch thick; the top and bottom, shaped wall-pieces, and vertical styles to be $\frac{7}{8}$ inch thick; and the back boarding about $\frac{3}{8}$ inch thick, grooved, tongued, and beaded. The whole can be made of any desirable wood either varnished or painted. Pitch pine will be very suitable, and, if nicely dressed and varnished, will have a good

appearance. White wood will be all that is necessary if the rack is to be painted.

A SMALL CHAIR

PLATE III.—The small chair shown in this Plate is of the simplest construction, and is so fully detailed in the several drawings as to practically require no description. The design is suitable for a light dining-room chair, and can be carried out in almost any hard wood, preferably rich English or wainscot oak, Spanish mahogany, or black walnut. If mahogany is used, the form of back indicated in Fig. 5 should be preferred to the other more solid forms given, which are more suitable for oak or walnut. Fig. 1 is a side view of the chair; Fig. 2 a front view; Fig. 3 an alternate design for the back of the chair; Fig. 4 shows the frame of the seat, which is to be upholstered, in the usual manner, with cross-webbing, canvas, hair-stuffing, and leather; and Fig. 5, already alluded to, is a plain back suitable for mahogany. The chair can be stained to any colour desired, and polished or varnished in any manner.

A STANDING BOOKCASE

PLATE IV.—The design given in this Plate is for a convenient standing bookcase, capable, according to the width indicated, of containing a small home library of about one hundred and sixty books of the

average thickness. Four tiers of books are provided for; but, in the event of many small books obtaining, another shelf can be added, and, if necessary, a few inches may be added to the general height without affecting the design. The construction is extremely simple, and within the powers of any amateur reasonably expert in the use of the ordinary tools. Fig. 1 is a front view of a little more than half the width of the bookcase; but the width can be increased or diminished as requirements may direct. Fig. 2 is a vertical section through the centre of the bookcase, showing the shelves and the rows of small holes bored in the end planks for the adjustment of the shelves at any desirable height. Fig. 3 is a horizontal section, showing the manner in which the end planks are tongued into grooves formed in the shaped standards, and the $\frac{1}{2}$ inch, grooved, tongued, and beaded back boarding. The manner in which the shelves are supported on small metal rings, the shanks of which enter the adjusting holes, is indicated by the dotted rings at the end of the shelf shown. The four shaped, end standards to be 5 inches wide at bottom, $4\frac{1}{4}$ inches wide at top, and $\frac{7}{8}$ inch thick; the shelves to be $\frac{7}{8}$ inch thick, as they are long and books are very heavy; and the bottom and top to be 1 inch thick. The best woods to be used are oak, teak, or black walnut; but either sequoia or pitch pine can be used with a satisfactory result. Any desirable

finish can be adopted to suit other articles of furniture in the room.

AN OCCASIONAL TABLE

PLATE V.—The design given in this Plate is for an occasional or small tea-table, the top of which is hexagonal. It is carried on six straight and flat supports, which are simply ornamented with quatrefoil perforations, the foils of which are readily cut with a Clarke expansive bit—1 inch radius—and the centres removed with a small saw or chisel. The construction is extremely simple, all the parts being easily put together by means of small blocks and screws, no gluing being required. Fig. 1 shows the table complete. Fig. 2 is a vertical section of the lower portion, showing the position and blocking of the shaped stay-board. Fig. 3 is a horizontal half-section, cut on the line C—D, showing the underside of the shaped stay-board, with its system of blocking attaching it to the vertical supports. Fig. 4 is a horizontal half-section on the line A—B, showing the underside of the hexagonal top, and the blocking by which it is attached to the vertical supports. If the table is made of oak or Spanish mahogany, the supports need not be more than $\frac{3}{4}$ inch thick, and the top $\frac{7}{8}$ inch thick; but if soft wood is used, to receive paint, thicker material should be employed, as indicated. A great variety of artistic

effects can be produced by the applications of the different stains now used on oak and other light woods, and any style of finishing may be adopted, as taste may direct.¹

A HALL TABLE

PLATE VI.—The small table illustrated in this Plate is suitable for a furnished entrance hall or for a library. It is of a substantial character, and Gothic in style; and, accordingly, should be made of English or wainscot oak, or of teak and plain oak combined—the framework to be of oak, and the perforated end panels and the top to be of fine teak. The small wedges securing the several tenons to be of rosewood or ebony in all cases. The construction is clearly shown, and, accordingly, requires no description. Fig. 1 is an end view of the table. Fig. 2 is a side view, cut in the middle to indicate that the table can be made any length that may be desired. Fig. 3 is a cross-section of one sloping support, showing the grooving-in of the end panel adjoining, and the tenon and wedge of one of the middle horizontal bars. The wood can be left in its natural state, or stained or polished as taste may direct.

¹ Two designs for occasional tables are given in Plates XVI. and XVII. in *The Art of Polychromatic and Decorative Turning; A Practical Manual for the Professional and Amateur Turner*, by G. A. and B. Audsley, published by George Allen & Company. The designs alluded to present a novel system of decoration by means of geometrical inlaying and studding.

AN OCCASIONAL TABLE

PLATE VII.—The design given in this Plate is for a small round, occasional or tea-table, differing widely in style from that given in Plate V. In the present design four broad, shaped, and perforated supports are introduced, the general treatment of which points the way to other outlines and perforated patterns of practically endless variety. Fig. 1 is a side view of the complete table. The perforations are to be cut by means of the bow-saw, started in each one from a brace-bit hole. The construction is very simple. The lower and upper horizontal cross-rails are halved together in their centres, and their ends are tenoned into the supports slightly, as indicated by dotted lines. All the rest of the fixing is done by means of small blocks screwed to the respective portions of the table, all of which are shown. Fig. 2 is a view as seen from the bottom of the table (a little more than one-half being drawn), showing all the blocking in position; namely, the blocks which secure the lower cross-rails together and to the small round shelf A; and those which attach the four supports to the table-top B. Fig. 3 is a view close to the underside of the top B, showing sections of the supports, the upper cross-rails C, and the blocks which secure the top to the supports at D. Respecting the woods to be used, and modes of

finishing to be adopted, see the concluding remarks in our description of Plate V., all of which are applicable in connection with the present table.

A SMALL TEA-TABLE

PLATE VIII.—The design given on this Plate is for a small square table in the Elizabethan style, suitable for an afternoon tea-service, or for any other occasional use. Small tables of this class are most convenient in a hall, drawing-room, or sitting-room. Fig. 1 is a side view of the table complete, and the characteristic manner in which the four supports are perforated. If variety is desired, the patterns of the oblong portions of the supports can be of different designs, care being taken to have a similar balance of the solids and perforations: the bottom portions should be the same in the four supports, or a disturbed effect will be produced. Fig. 2 is a horizontal section, showing the form of the lower cross-bars: these are halved together in their square, central parts, as indicated by the dotted lines, and glued; their ends passing through the supports, and being firmly fixed by wedges, as shown. The cross-bars need not be pierced; and any characteristic contour may be given to their edges. Fig. 3 is a horizontal section immediately under the upper cross-bars. These bars are halved together in the centre and let into the tops of the supports in the manner indicated in

Fig. 4. The ends of the bars are carried in front of the supports, forming brackets to support the top of the table, as shown in all the drawings: these can be left unpierced, and shaped in any desirable manner taste may suggest. The top is attached to the supports and the cross-bars by the system of blocking and screwing shown in Figs. 1 and 3. The blocks against the cross-bars may be omitted, and the bars directly screwed to the top, the heads of the screws being deeply sunk in brace-bit holes.

The most desirable wood for this table is oak, and preferably English oak—the wood always used for such furniture in Elizabethan times—finished with wax, hard rubbed to a slight gloss. If plain American or wainscot oak is used, it should be stained or fumed, and finished as above.

TWO PLANT STANDS

PLATE IX.—The designs given in this Plate are for quaintly formed and easily constructed plant stands. If well made of some good kind of hard wood, they will be suitable for any room or hall. Fig. 1 shows a square box, supported on four slightly shaped legs, which are screwed to the centres of its sides, as indicated by the dotted lines in Fig. 2. The legs are attached to the small shelf below—partly shown in Fig. 3—by means of small angle-irons, securely screwed underneath to both legs and shelf.

The sides of the box are shown pierced, but they can be left solid if preferred: the perforations necessarily involve considerable careful labour. The corners of the box are mitred, and cross-tongued with some dark wood, such as rosewood or ebony, as indicated in Fig. 1, and shown in detail in Fig. 4. This treatment has an ornamental effect. The corners of the box can be dovetailed if preferred. Fig. 2 shows the top frame of the box, mitred and tongued: this is held in position by the upper ends of the legs being let into it, and by being glued and pinned to the edge of the box, as indicated.

Fig. 5 shows the other stand, in all respects different in design, although practically similar in construction, to that shown in Fig. 1. Fig. 6 shows the interior of the box, and Fig. 7 the shelf underneath. The box may have perfectly plain sides, or they may be cut, after the fashion shown, or perforated in any manner taste may direct.

Zinc trays or inner linings should be provided for both boxes, to catch any moisture that may run from the flower-pots.

Any wood can be used according to taste, or as may be dictated by the furniture of the room in which the stand is to be placed. Soft wood painted has a very good appearance in ordinary cases. Decoration may be applied by either free-hand work or stencilling.

A HALL SETTEE

PLATE X.—The design shown in this Plate is for a settee of a simple and substantial character. Fig. 1 is a front view, and Fig. 2 is a vertical section, in which the construction is clearly shown. Such other details of the construction as the amateur joiner may require are indicated by dotted lines in both the drawings. Any desirable wood can be used; but American oak will be found quite satisfactory, stained any tint and wax-polished or oil-varnished. The design can, of course, be carried out in any length desired.

DRESS-TREES

PLATE XI.—The article for the formation of which two designs are given in this Plate is one that every lady will admit the utility of. Although the dress-tree as a piece of bedroom furniture is practically unknown in this country, its value and convenience are fully recognised in the United States. The dress-tree is more convenient than the ordinary wardrobe for the hanging up of articles of dress on retiring for the night, or for purely temporary use; and we feel sure, once it has been used, that its absence will always be regretted. The construction of this simple article of furniture is so distinctly shown in both the designs given, that a description of the same is absolutely unnecessary. The wood to be used should

be dictated by that of the furniture of the room in which the article is to be placed. The amateur joiner, desiring to make a present of a piece of his handiwork to a lady, could not select a more acceptable one than a handsomely finished dress-tree.

A LADY'S WORK-TABLE

PLATE XII.—The article of furniture the design and construction of which are shown in the present Plate is another convenience that will be recognised by every lady who plies the needle in any description of work. Its upper portion consists of a box for containing all the articles required in the processes of plain and ornamental needlework, the hinged lid of which serves as a small table. The shelf or tray below is for holding any articles, more or less bulky, that may be required from time to time. Such a table is conducive to tidiness and system, and can be readily moved about as required, handles being provided for that purpose. Although no lock is shown, one can be added to the upper portion if the maker thinks it desirable.

Fig. 1 is a side view, and Fig. 2 an end view of the work-table complete. Fig. 3 is a part section, showing the depth of the box and tray. Fig. 4 shows the construction of the table or lid, one corner being given, showing its mitred frame, securely tongued together, and its panel grooved and tongued to the

frame. Fig. 5 shows the manner in which the sides and bottom of the box are let into, and angle-blocked to, the legs. Fig. 6 shows enlarged drawings of the handles, and their attachment to the ends of the box. Any wood may be used in the formation of this piece of furniture; but seeing that it is of small size, and for a lady's use, we would suggest Spanish mahogany as the most desirable wood. If, however, the furniture of the room in which the work-table is to be placed is all of one description of wood, finished in a special manner, then the work-table should be made to match the same.

A HALL OR LIBRARY ARM-CHAIR

PLATE XIII.—The arm-chair shown in this Plate, although simple in its construction, furnishes a fair test of skill on the part of the amateur joiner. It is a piece of furniture that will repay the time and labour expended on its fabrication. A detailed description of its several parts is unnecessary, for every part is clearly shown, and all the jointing indicated by dotted lines. Enlarged drawings of the turned portions of the arm and back are given in Figs. 3 and 4. The lower part of Fig. 3 is a section through the horizontal side-rail, showing the insertion of the seat, and the manner in which it is fixed to the rail by sunk screws, covered by ebony or rosewood studs, as shown in Fig. 1, in which the studs are rendered in the form

of black dots. Fig. 1 is a complete side view of the chair; Fig. 2 is a complete front view; Fig. 5 is one of the arms, as seen from above, which is slightly checked into the sloping back-piece, to which it is screwed and studded, as indicated by the dotted lines; and Fig. 6 shows the seat let into the bottom rail of the back. The seat is shown solid for the reception of a cushion. The most suitable wood for such a chair is oak, and preferably English oak. Ordinary American oak, nicely stained, will be quite satisfactory. A combination of wainscot oak and teak (the latter being used for the triangular, pierced panels and the small cusped pieces between the turned standards) will be very pleasing and effective. Walnut or Spanish mahogany can be used instead of teak if more convenient.

A BABY'S CHAIR

PLATE XIV.—A very convenient form of a baby's chair is given in complete detail in this Plate. It consists of an arm-chair, furnished with a rest for the feet, and a tray or table on which food or toys can be laid as desired. This table has a raised edging to prevent things being easily pushed off, and is pivoted to the back, so that it can be turned over the same and dropped behind the chair when not required: this arrangement is indicated by the dotted lines in the side view of the chair, Fig. 2. The form of the

table is shown in the top view, Fig. 3; in which are also shown the attachment of the table to the back legs, the arms on which the table rests, and the dished seat of the chair. Fig. 4 shows the manner in which the table rests on the arms, and the small slip-bolt necessary to fix the tray so that the baby cannot lift it. Fig. 5 illustrates the manner in which the side bars of the tray are pivoted to the upper parts of the back legs: a strong screw and brass washer, and a button of hardwood or thick sole-leather forming the pivot for each side bar, as indicated in Fig. 3. Figs. 6 and 7 show the manner in which the seat is notched into the legs, and securely fixed to the same with sunk screws; the outer holes for which are filled with small turned studs, as shown in Fig. 7. The front view of the complete chair is given in Fig. 1. The chair may be made of any of the hard woods described in Chapter II., and should be finished with a durable oil varnish. This finish is especially necessary for the table.

A LIBRARY OR BOOKCASE TABLE

PLATE XV.—The quaint table illustrated in this Plate is an extremely useful article, and is admirably suited for a small library or sitting-room. It combines the ordinary convenience of a table with a bookcase. Between the end supports are shelves, as shown in the section, Fig. 2, and the part end view, Fig. 3. If the

shelves are made 1 ft. 9 ins. long, the table will hold about eighty volumes of the average size, without placing any behind the front rows. Fig. 1 is a side view of the table complete, and Fig. 4 furnishes an alternative design. A tray is provided between the supports, carried on the level of the lower bookshelves, convenient for holding magazines, newspapers, &c. The length of the table as shown is 3 ft. 4½ ins.; but this can be extended by separating the supports by longer intermediate pieces of any desirable form, or perfectly straight if preferred. Figs. 5, 6, and 7 fully explain the simple construction, supplemented by the dotted lines in Figs. 1 and 3. The table may be constructed of any of the woods described in Chapter II., but oak would seem to specially commend itself. Of the soft woods, pitch pine would be the most suitable. The small wedges should be of rosewood or ebony.

A MEDICINE CABINET

PLATE XVI.—A small cabinet for containing medicines, under lock and key, and suitable for fixing to a bedroom or bathroom wall, is a desirable article in every house. Medicines should never be left lying about; while they should always be readily found when required.

The design given in this Plate is for a cabinet of an ornamental character, such as would repay the

amateur joiner for the time and care expended on its fabrication, and which would not be out of place in even the most richly furnished bedroom. Every detail of the construction is carefully shown in the several drawings given in the Plate. Fig. 1 is a front view of the complete cabinet, showing its door, panelled with a bevel-edged plate-glass mirror (a wood panel can be inserted if preferred). Small shelves flank the cabinet, which may hold ornaments, or bottles and glasses in frequent use. Fig. 2 is a side view, showing the projections of the cabinet and the shelves. Fig. 3 is a vertical section through the centre of the cabinet, showing its three shelves. It is unnecessary to remark that the contour of the back-board on which the cabinet is built can be varied in any manner that taste may direct. Any of the hard woods may be used in the construction of the cabinet, and any desirable finish can be adopted.

A TRIPLE PLANT STAND

PLATE XVII.—The article shown in the present Plate, in complete detail, is a triple stand intended for the display of plants in full flower. The three boxes are so disposed as to give a pyramidal effect to the display. Plants of a somewhat tall habit should be placed in the lower, lateral boxes; while the plants occupying the central box may properly be of a more compact and spreading habit. We pass these remarks

to show the idea which dictated the design. The side view of the stand is given in Fig. 1. Fig. 2 is a vertical section through one of the end boxes, on the line A—B, showing also an end of the central box. Fig. 3 is a vertical section through the centre of the stand, on the line C—D. These three drawings show to the fullest extent the general construction of the entire article; but to leave nothing to the imagination of the amateur, enlarged details, showing the methods of jointing, are given in Figs. 4, 5, and 6: these require no explanation, as the portions of the stand they represent are obvious. The perforations in the sides of the boxes are purposely made simple, and only call for the use of the brace and bits. Any wood may be used in the construction, and the whole may be finished with varnish or oil paint, as circumstances or taste may direct.

A MUSIC-ROLL CABINET

PLATE XVIII.—Few articles of furniture are, at the present time, more desirable in numerous houses than such a cabinet as that illustrated in this Plate. The great and continually increasing demand for the Pianola Piano and the Pianola attachment to the ordinary pianoforte, and the consequent necessity for a collection of the perforated music-rolls, renders it highly desirable that a properly constructed and convenient cabinet should be possessed, in which the rolls

can be kept in safety and in order, and without loss of space. The form of cabinet which fulfils all these conditions is set forth in the simple design given. Fig. 1 is a front view of the cabinet, showing its door, filled with simple leaded glass. Fig. 2 is an end view, severely plain in construction. Fig. 3 is a vertical section through the cabinet, showing the series of shelves for the reception of the perforated music-rolls. It will be observed that the shelves do not extend the full depth of the interior: this is done so as to allow the roll-boxes to project perfectly free of the shelves, and, accordingly, be easily withdrawn and replaced. In Fig. 4, which is a horizontal section through the cabinet, the relation of the shelves to the internal space is indicated. Fig. 5 is a section immediately under the top. Fig. 6 is a section through one style of the door and its adjoining angle-piece. Fig. 7 is a section through the end panelling, a back angle-piece, and the back-board, showing the jointing of the same. Some good hard wood, such as Spanish mahogany or choice wainscot oak, should be used for all the exposed portions; bay-wood being used for the shelves, bottom-board and back-board in either case. When mahogany is used, it should be French-polished; but when oak is employed, any finish that taste may direct can be adopted. Any design may be carried out in the leaded glass; and in all cases the leads should be gilded.

A SMOKER'S CHAIR

PLATE XIX.—The lounge chair represented in this Plate will be appreciated by every smoker and reader, combining, as it does, practically every element of comfort and convenience he can reasonably desire and expect in one article of furniture. The chair is fitted with a sloping seat for the reception of a cushion, and a back which can be adjusted to any desirable angle. The right arm is made broad to carry a book or any article in use, and is fitted with an ash-bowl. On the left side of the chair is a projecting portion for holding newspapers, &c. The eight drawings given in the Plate show in the clearest manner the formation and construction of all portions of the chair. Fig. 1 is a side view of the complete chair, showing the front of the projecting newspaper-holder, and one of the fittings which allow the adjustment of the inclined back. Fig. 2 is a front view of the complete chair, showing the end of the right arm, supported by a small bracket screwed to the front leg, and also the front end of the newspaper-holder, below the left arm. Fig. 3 is a vertical section through the seat, showing the slope of the same, and the hinging of the bottom rail of the back. Fig. 4 is a horizontal section of the left portion of the chair, immediately above the newspaper-holder. (To prevent confusion of lines the solid bottom of

the holder is not indicated by graining.) The bottom of the holder is indicated by dotted lines in Fig. 2. Fig. 5 is a top view of the broad, right arm with its ash-bowl: its rear end forms portion of the fittings provided for the adjustment of the back. Fig. 6 is a corresponding view of the narrower, left arm, showing its portion of the fittings for the adjustment of the back. Fig. 7 is an enlarged drawing of the rear end of the left arm, showing the brass pin which passes through the holes bored in it—shown in Fig. 1—and against which the back rests. Fig. 8 is a section through the ash-bowl inserted in the right arm. By means of the system of dotted lines in all the drawings, the details of the construction of the chair can be thoroughly understood. We strongly recommend oak to be used, although the chair may be made of any hard wood. Any desirable finish can be adopted. As the seat is sufficiently deep, a cushion may be applied to the back if desired.

A DRESSER SIDEBOARD

PLATE XX.—The piece of dining-room furniture the front view of which is given in this Plate will probably be somewhat beyond the powers of the average amateur joiner; but there will be some expert wood-workers who will not hesitate to undertake the task of its construction. In designing the sideboard, we have purposely avoided all difficult work. Con-

sidering the importance and great utility of the article, all the time and labour expended in its fabrication would be amply repaid.

PLATE XXI.—In this Plate all matters connected with the construction of the sideboard are made perfectly plain. Fig. 1 is an end view of the sideboard in its complete form. If it is desired to save time and labour, plain panelling may be used, and the ends of the upper or dresser portion may be left straight and unpierced. Fig. 2 is a vertical section, showing the construction of one of the sideboard cupboards, and also showing the construction of one lateral division of the dresser portion. Fig. 3 is a horizontal section of the dresser, cut above the upper shelf, for the purpose of showing the front outline of the shelf to cover the projection of the centre cupboard, which is indicated by the dotted lines. Fig. 4 is an enlarged drawing of one of the legs, and Fig. 5 a similar drawing of the central support above the dresser cupboard—shown in Plate XX. Fig. 6 is a section through one of the cupboard doors, showing its construction and the shape of its panel. Furniture of this class seems to call for oak in its construction, and always presents the best appearance when it is stained very dark and wax-finished. These facts need not, however, prevent any other wood being used if preferred.

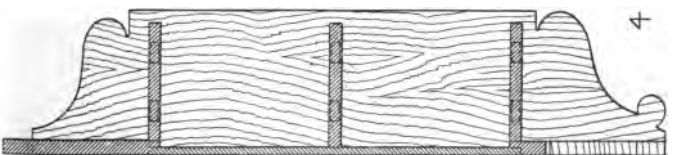
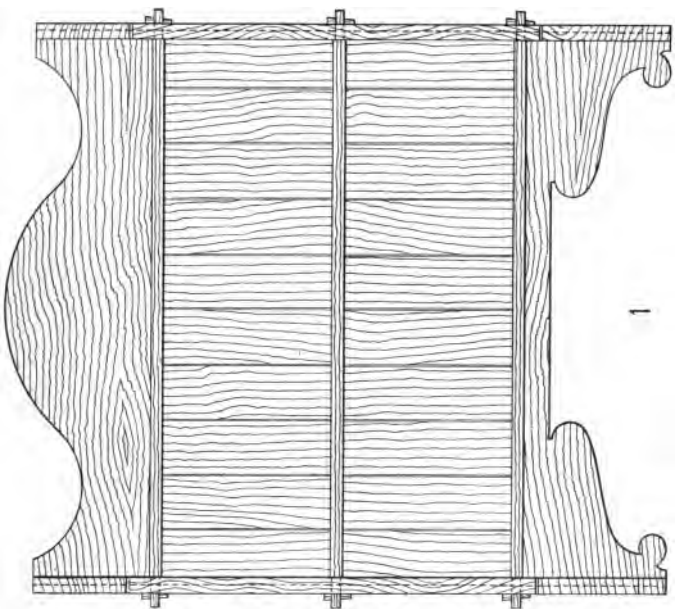
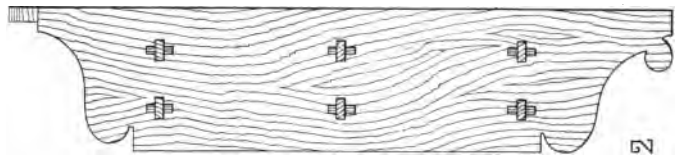
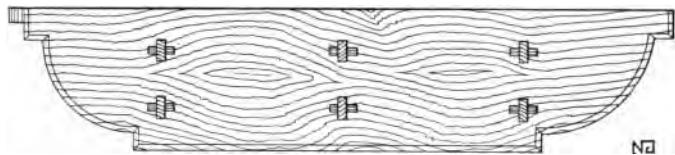

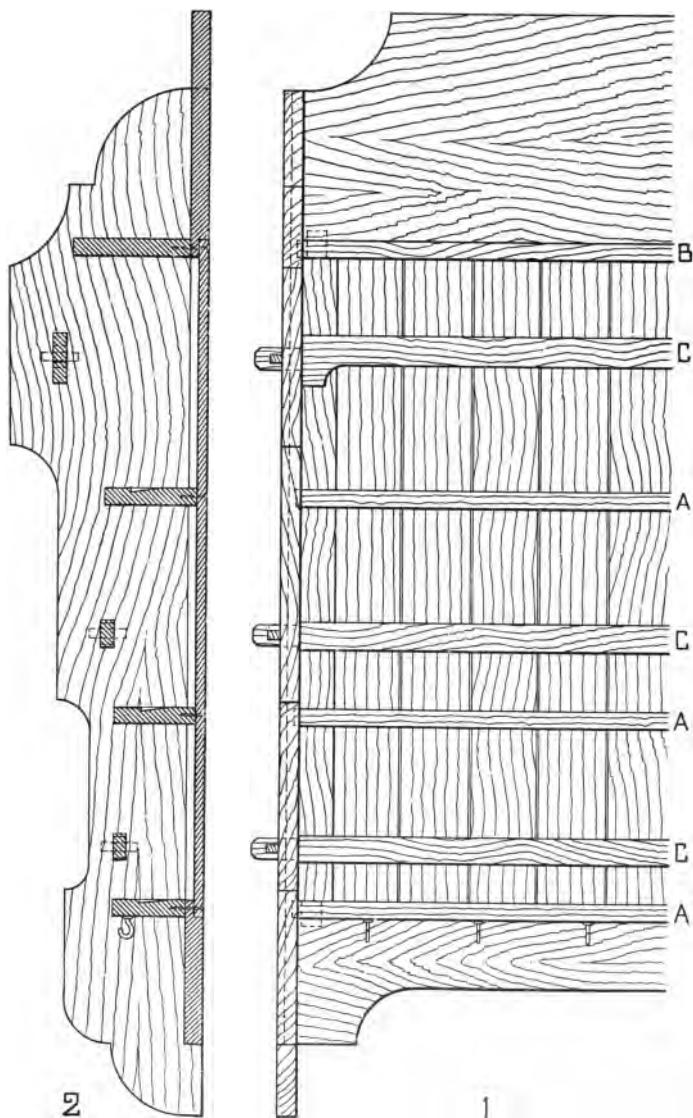

12" 0 1'

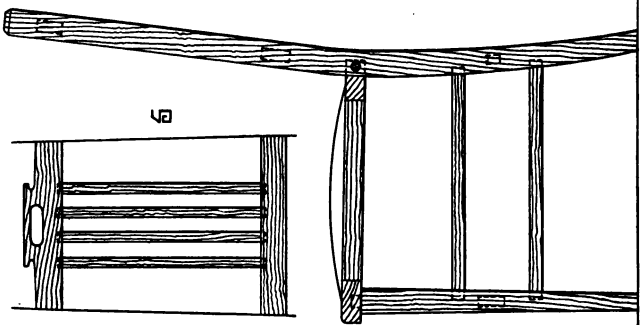
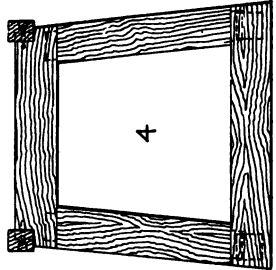
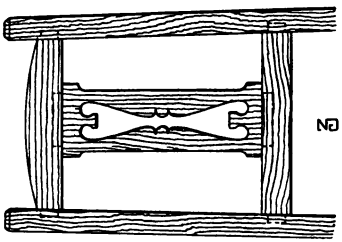
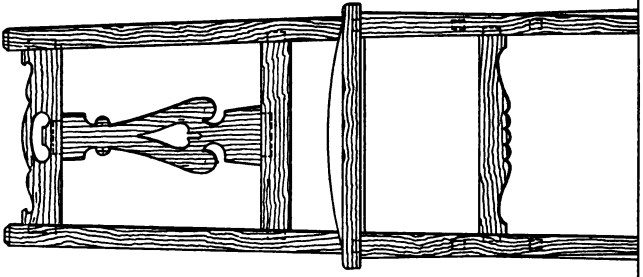

2

9

12"

1

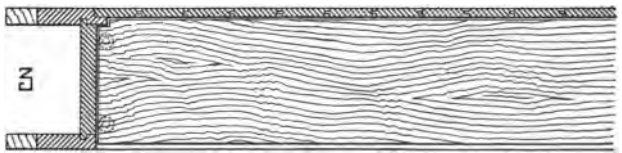
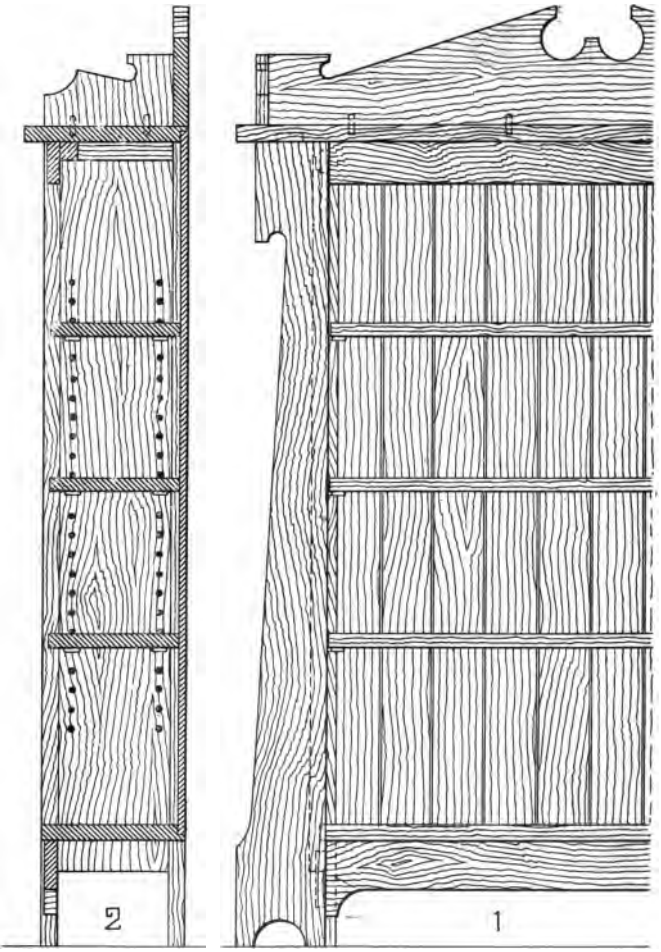

12" 0 1'

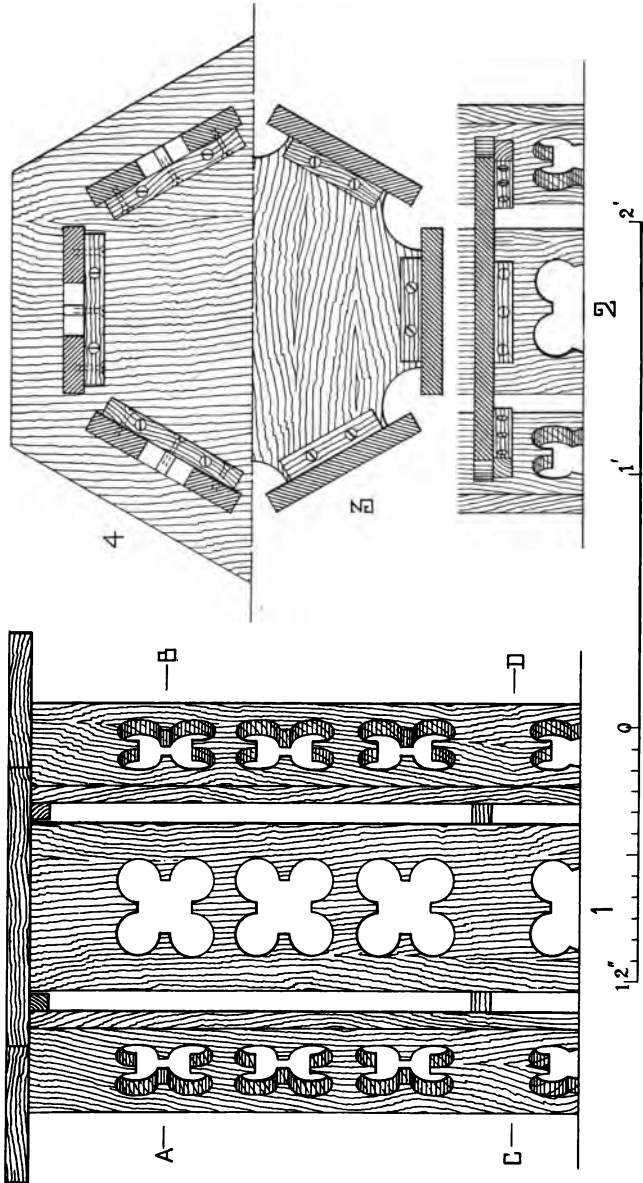

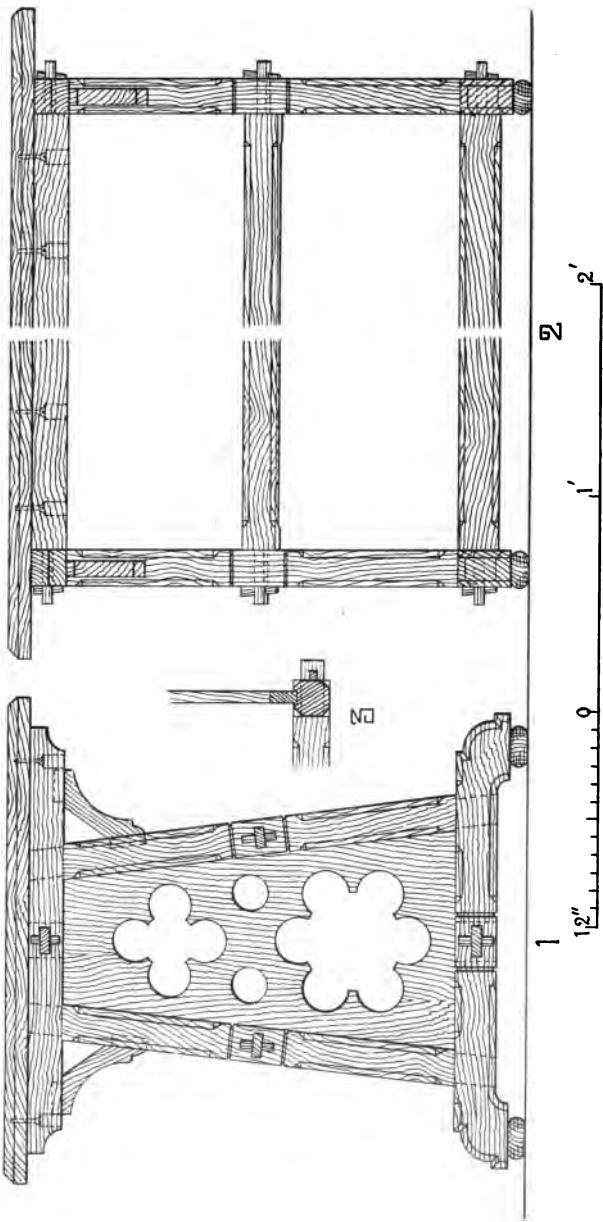

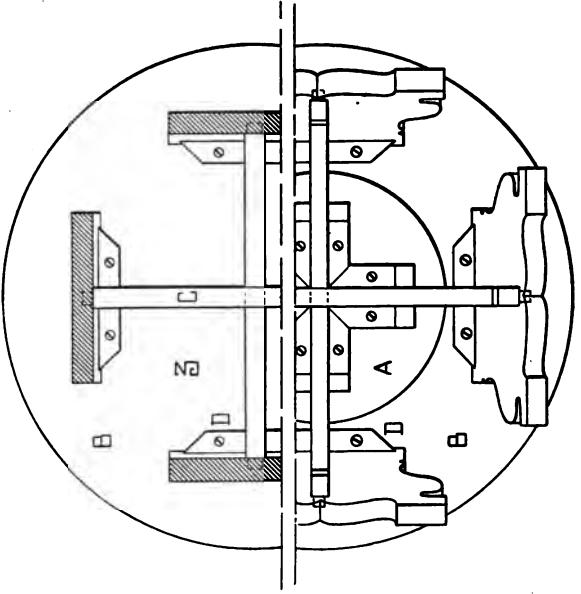
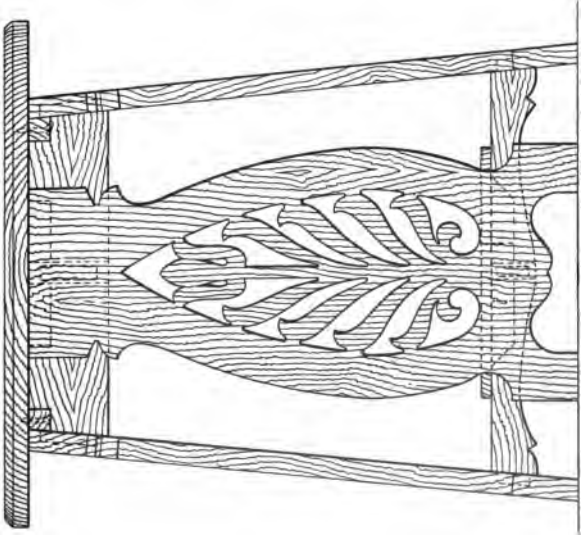

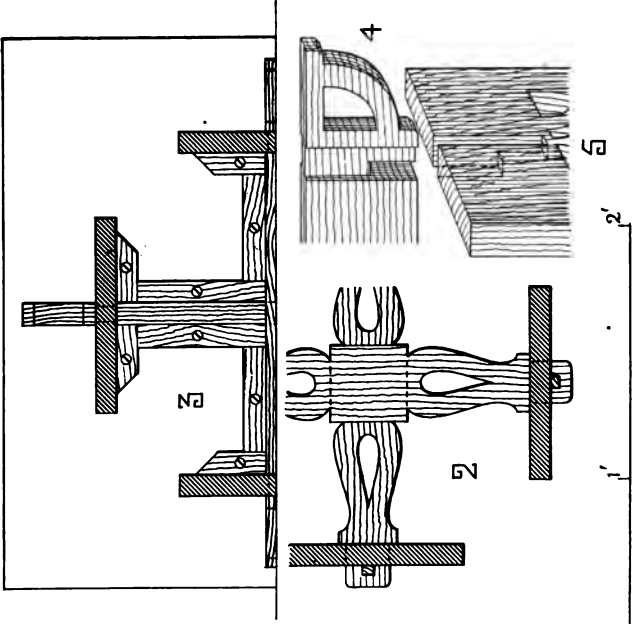
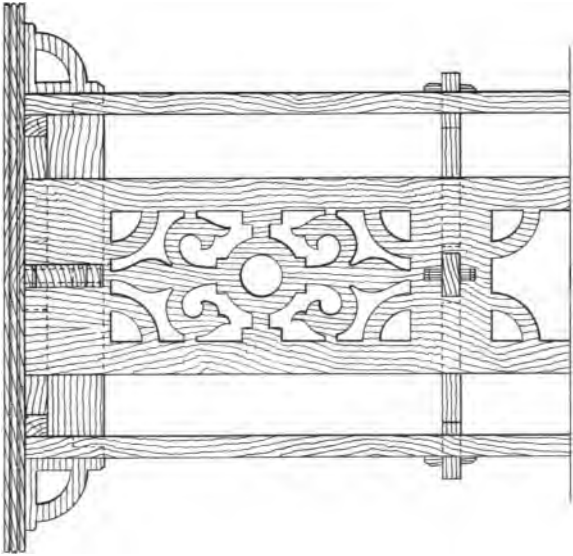

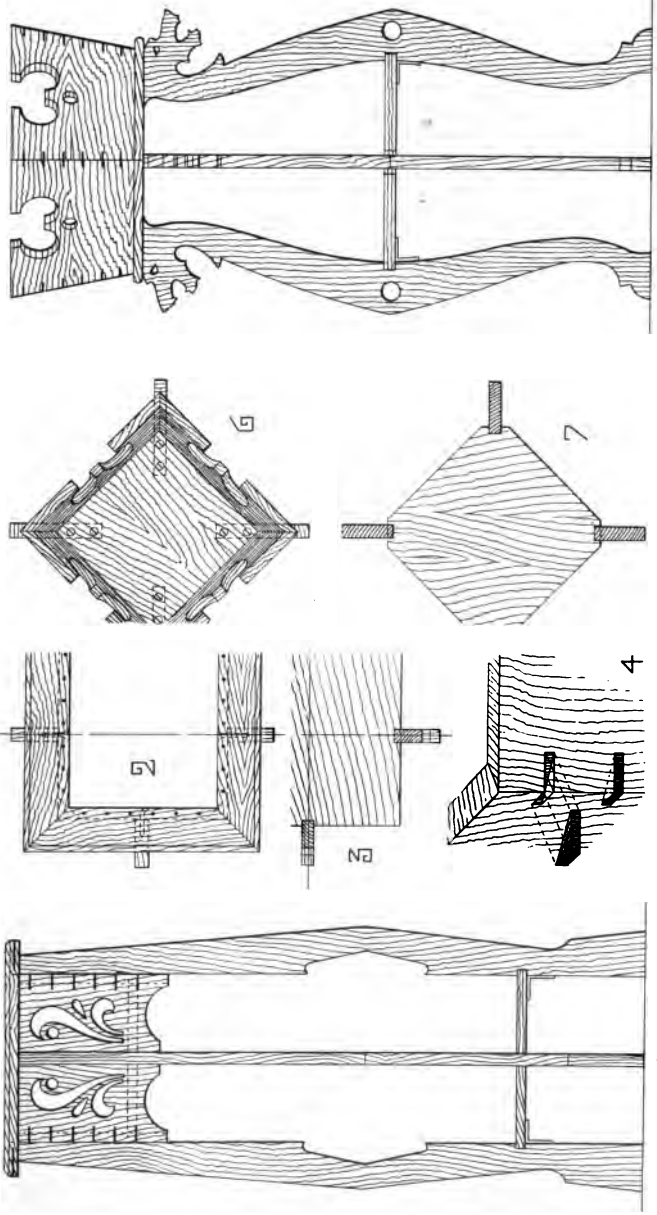

5'

5'

2'

1'

0

12"

1

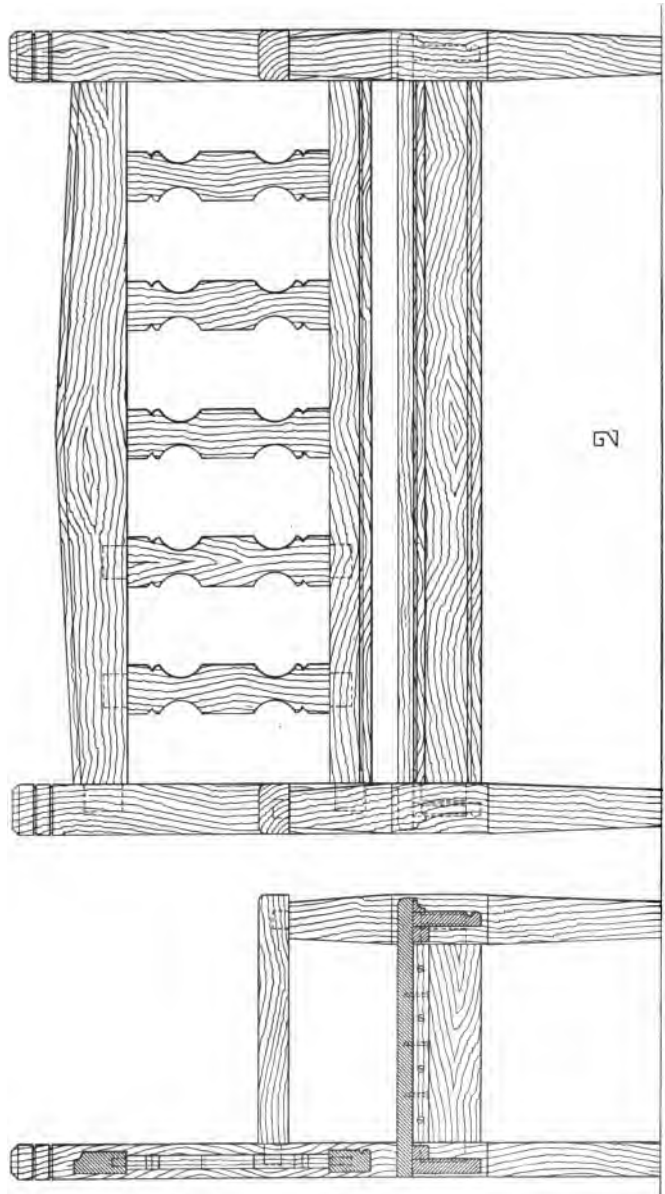

5

12" 0 1 2'

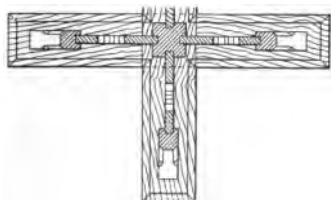
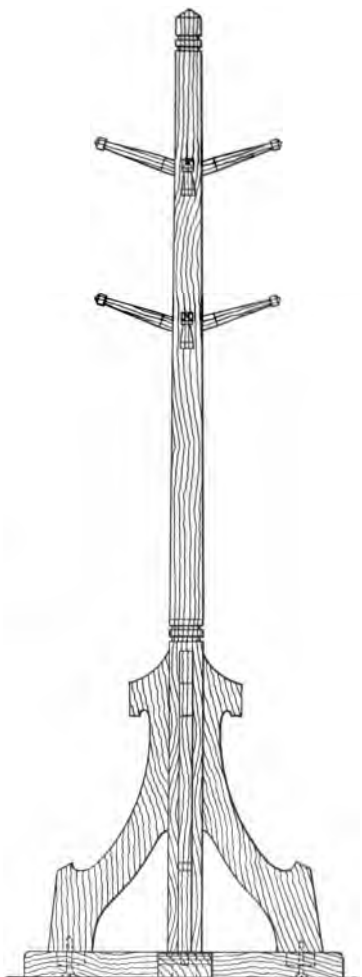
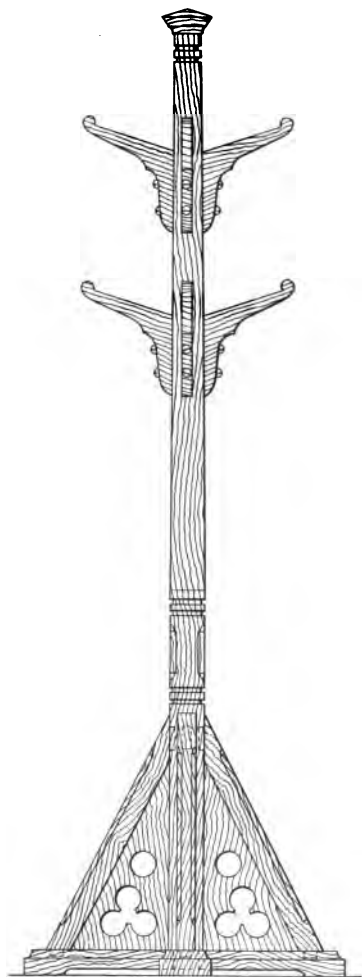

12" 0 1' 2'

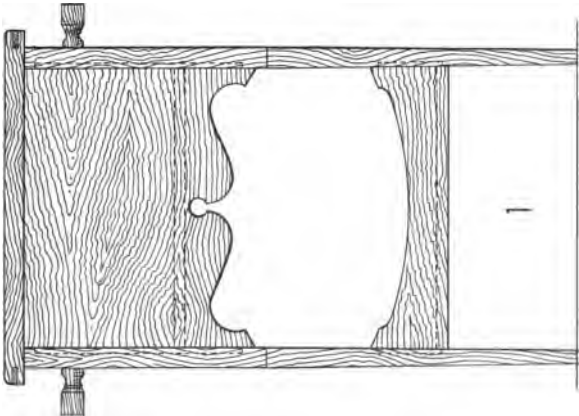
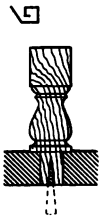
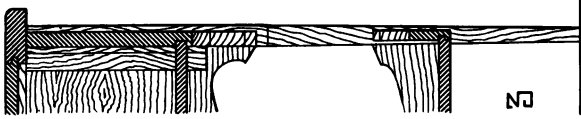
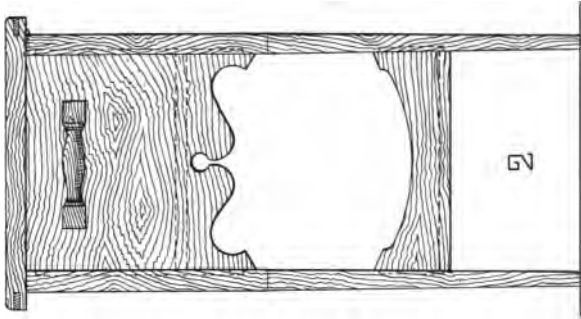

12" 1' 2"

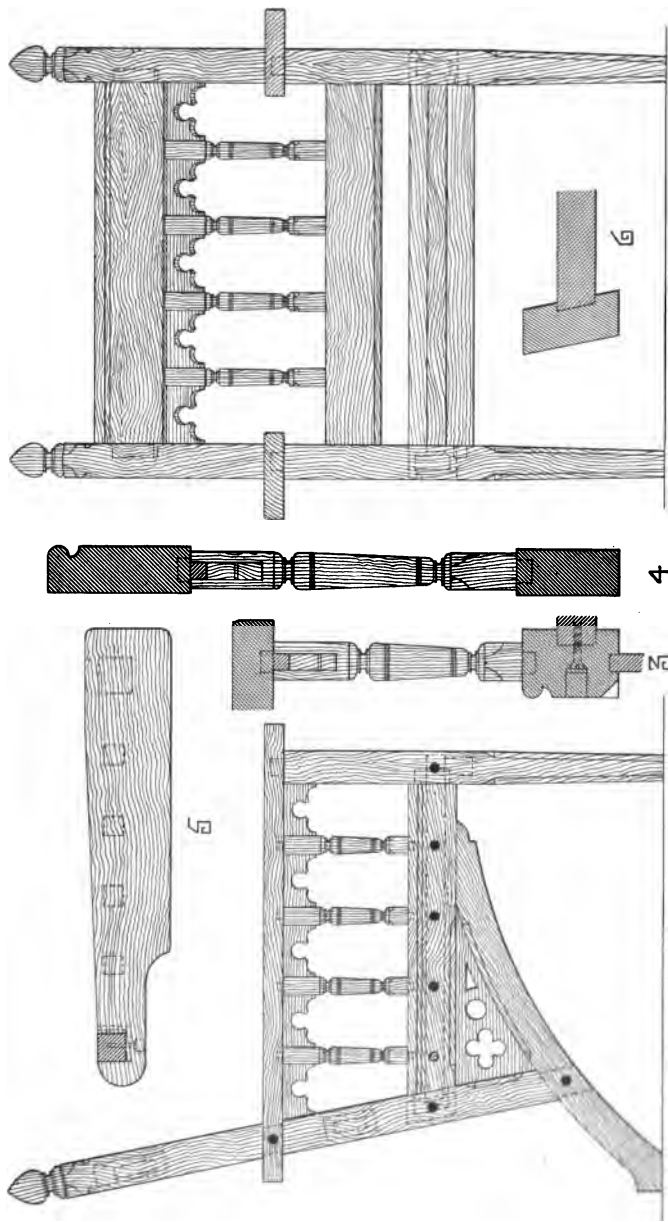

1' 12" 9

1 12" 9

4

3

5

6

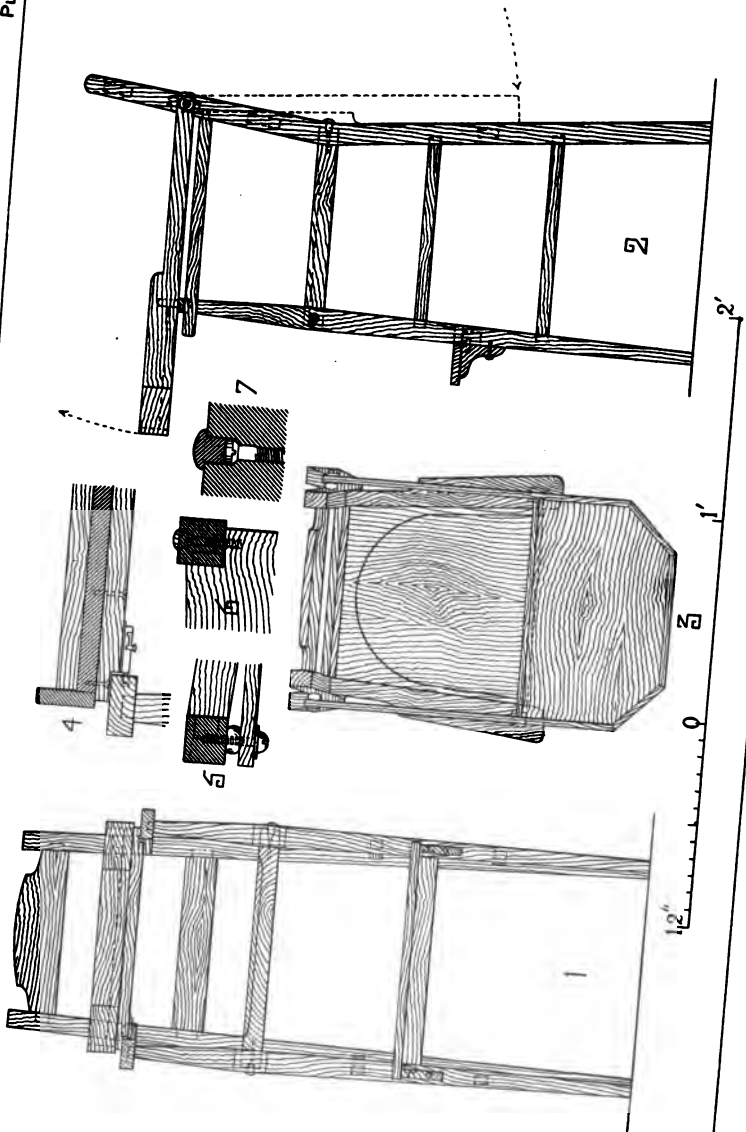

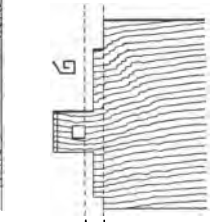
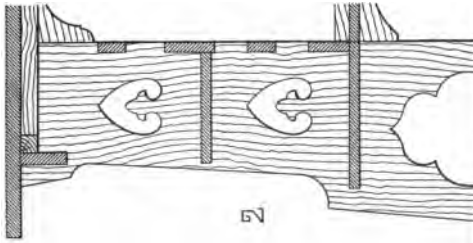
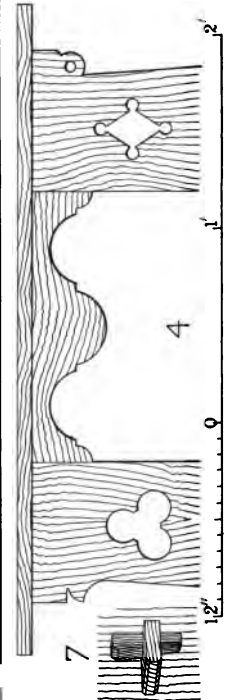
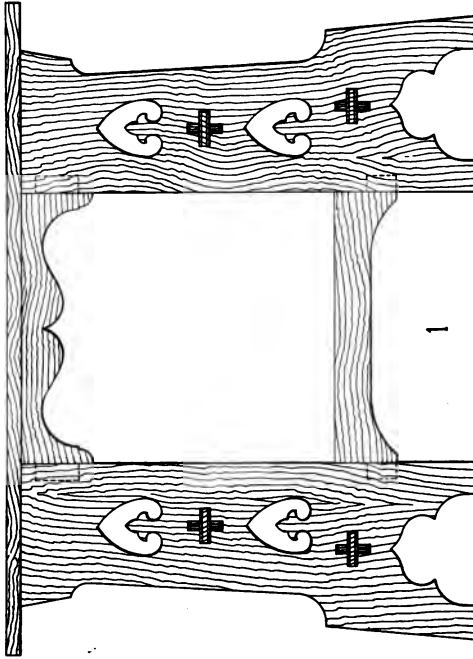
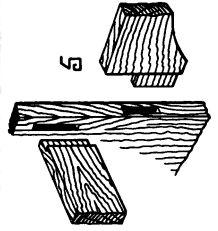
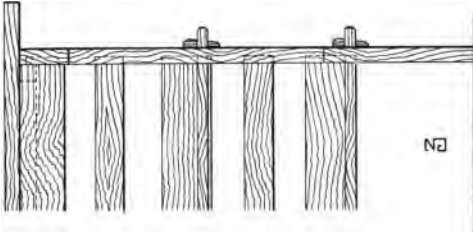

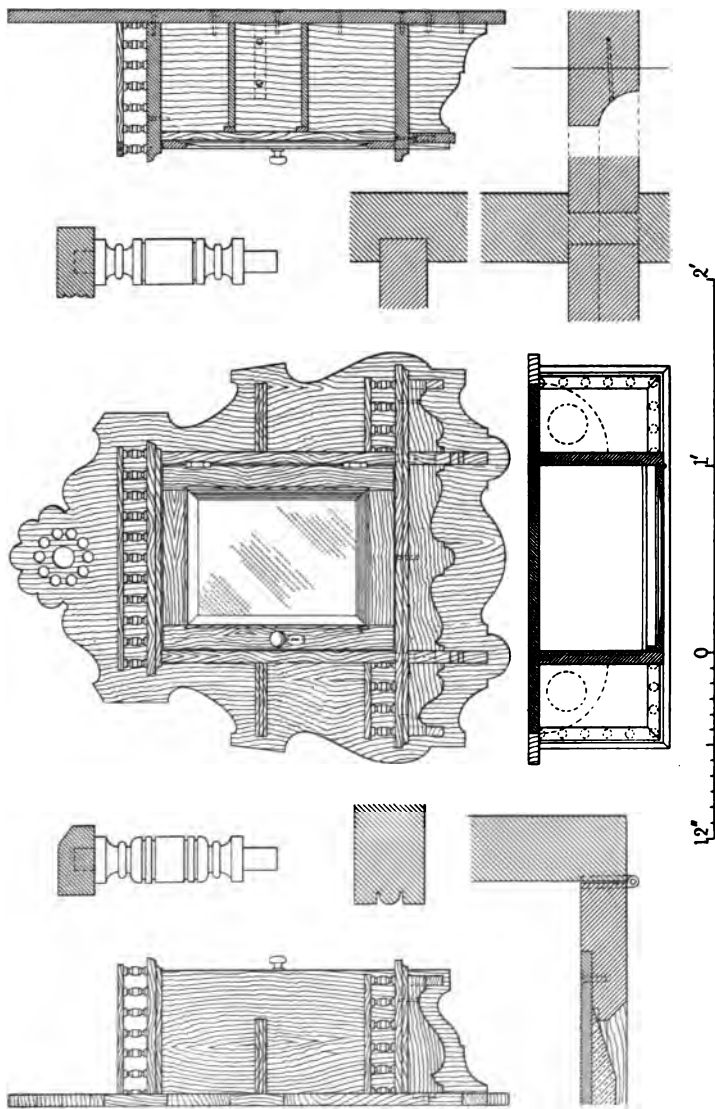

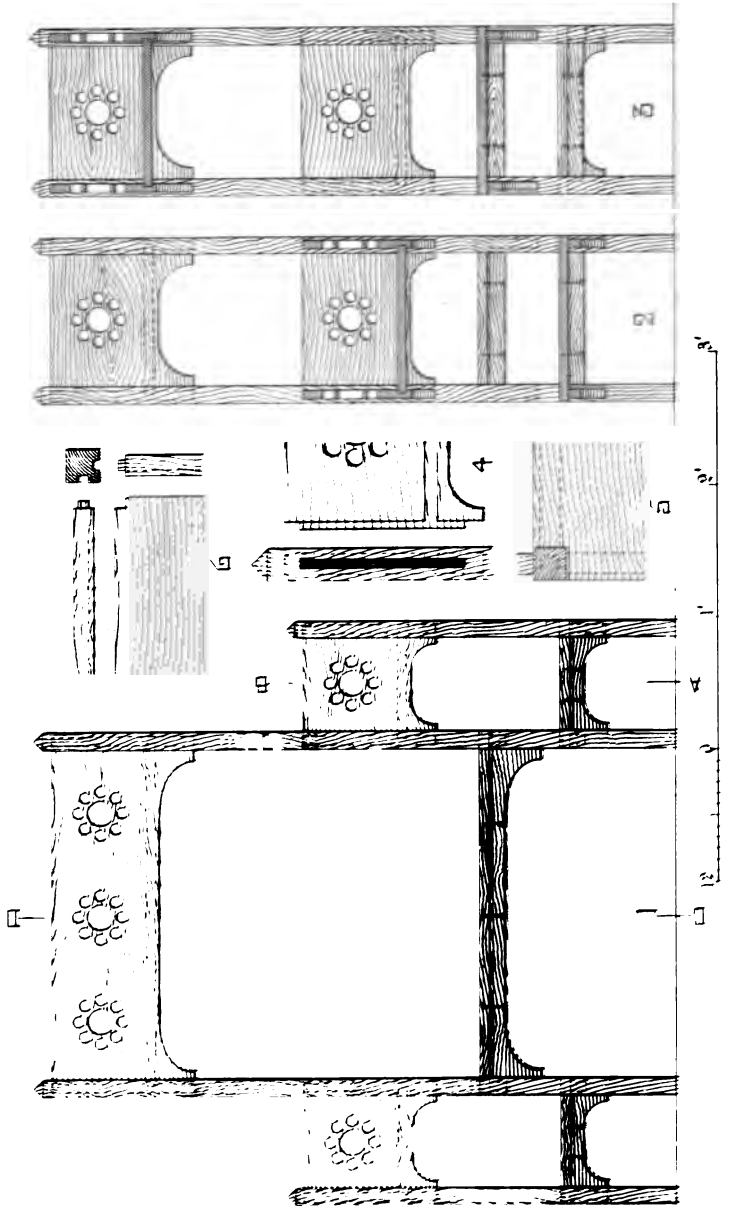

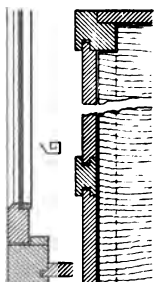
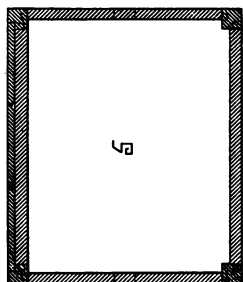
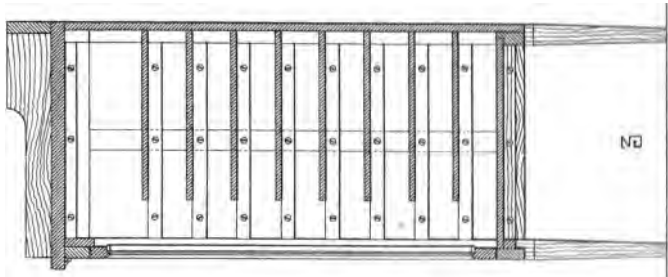

7

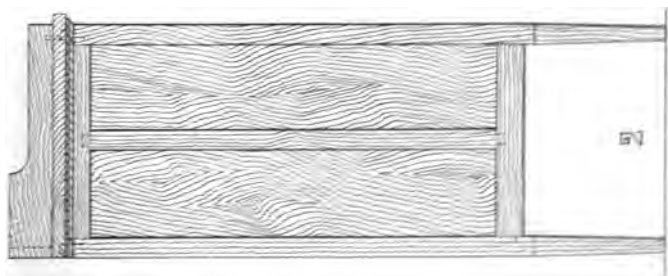
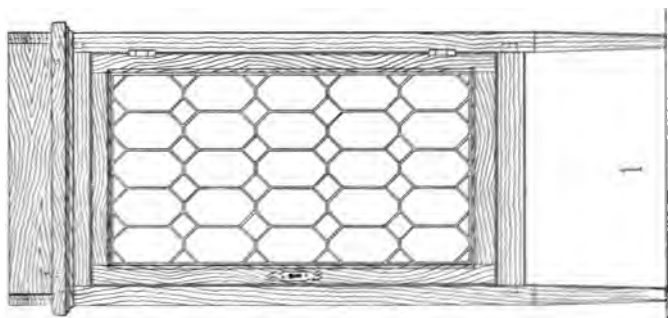
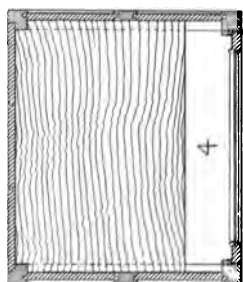

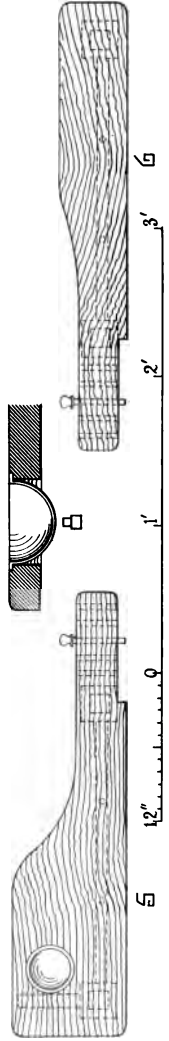
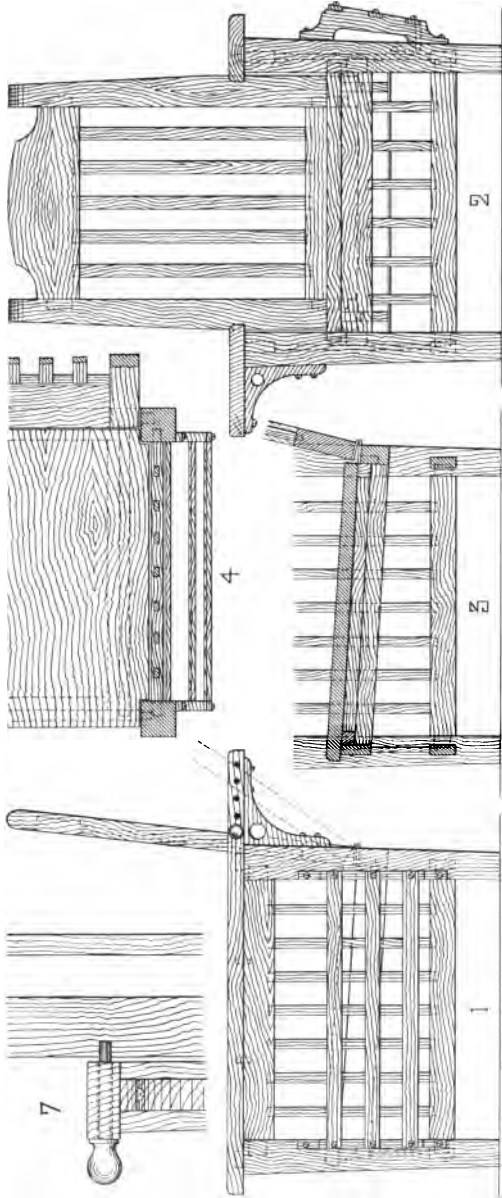

pl 20 furniture

